



# Hydraulic Catalogue 2012

Quick Coupling Systems for Medium- and High-Pressure

aerospace  
climate control  
electromechanical  
filtration  
fluid & gas handling  
hydraulics  
pneumatics  
process control  
sealing & shielding



ENGINEERING YOUR SUCCESS.

# THE RIGHT SOLUTION FOR EVERY SECTOR!



Whether under water, in aerospace, on the high seas, on the street, or in industry – our quick connect coupling systems are at home in many domains and represent the right solution in numerous technical applications.

The modular structure of our series allows you to benefit from a wide standard range, which includes a suitable system for most applications – just-in-time goes without saying.





# ARE YOU HOPING TO FIND WITHOUT LOOKING? THEN WE HAVE JUST THE THING FOR YOU!

## Ball Locking Systems

### ISO Standard Profile

ISO A	Page	14	to	25
ISO B	Page	26	to	35
ISO F	Page	36	to	43



### Tema Profile

T-Series	Page	44	to	51
H-Series	Page	52	to	55
FF-Series	Page	56	to	59



### Parker Profile

SM-Series	Page	60	to	63
ST-Series	Page	64	to	67
NS-Series	Page	68	to	69



### Screw-to-Connect

QHPA-Series	Page	70	to	73
6100-Series	Page	74	to	77



### Multi Couplings

MACH	Page	78	to	81
MACH2	Page	82	to	83
C-Line Compact	Page	84	to	87
C-Line Standard	Page	88	to	93
C-Line Accessories	Page	94	to	101



3000-Series (700 bar)	Page	102	to	103
SK-Series (750/1100 bar)	Page	104	to	105
FF2500-Series (800 bar)	Page	106	to	107
HP1000-Series (1000 bar)	Page	108	to	109
HP1500-Series (1500 bar)	Page	110	to	111
High Pressure Adapters	Page	112	to	113



System 100	Page	114	to	119
PJS	Page	120	to	121
PD-Series	Page	122	to	125

Swivels (DG/KR)	Page	126	to	129
Pressure Relief Valve	Page	130	to	131
Check Valves	Page	132	to	133
Thermal Valve	Page	134	to	135

### Important Notes:

- Please note that the technical data, specifications and drawings in the catalogue are not binding. This information is subject to change without notice in the interest of improvement.
- We reserve the right to make technical modifications for the purposes of improvement.
- March 2012: With the actual catalogue the older versions are no longer valid.
- The interchangeability is guaranteed under the assumption that the manufacturer of the relevant product has not changed any functional part in the meantime.
- You will find important safety instructions on pages 12 and 13.





## Medium Pressure

Find information about our wide range of medium pressure products on these pages used for pressures up to 300 bar. We clustered the products in their profiles such as ISO, Tema and Parker profiles to ease up your selection process. Here you can also find a chapter for our screw-to-connect couplings and our multi-coupling solutions where you can handle up to six couplings in a single operation.



### FlatFace Systems

Identify all products with a FlatFace coupling design from this sign. They have a non-drip, dry-break function that also avoids air and dirt insertion in the hydraulic circuit. The flat surfaces ensure an easy cleaning especially in harsh mobile hydraulic applications. So it's an ideal alternative and an environmental friendly solution.



### Pressure Eliminator

By using this technology residual pressures in hydraulic lines that avoid coupling can be overcome smoothly and without enormous efforts. A special valve design automatically releases any residual pressure and guarantees the functionality of the coupling.

## High Pressure

This chapter provides information on our systems for use with high pressures up to 1500 bar for various applications in mobile, stationary industrial and hydraulic

areas. In here you can also find our range of high pressure adapters for a lot of hydraulic tasks.

## Diagnostics

Hydraulic lines or circuits have to be checked constantly due to pressure or quality of the hydraulic medium. With our diagnostic products these test can

be done easier even under working pressure conditions, to reduce disturbances of the processes to the bare minimum.

## Accessories

Besides our wide range of coupling solutions we also provide you with high-quality, helpful accessories that complete our offer and gives you the opportunity to

get all components you need from a single and reliable source.

### Key to Symbols in Application Area

- Machinery Construction
- Food Technology
- Chemical Technology
- Mobile Hydraulics
- Trade
- Medical Technology
- Safety Technology
- Electrical Engineering
- Aeronautics
- Automotive

# ABOVE ALL ELSE, OUR SYSTEMS OFFER YOU GREATER SAFETY.



## The FlatFace Concept

Dirt-proof FlatFace couplings have the following advantages: Non-drip, dry-break function on disconnection, no air is trapped in the system during connection and extremely flat surfaces to ensure easy cleaning. Depending on the application, the FlatFace concept is the ideal alternative for an environmental high-quality solution.



## The Pressure Eliminator

By using this innovative Tema patented technology, residual pressures in hydraulic lines can be overcome smoothly and without effort. The use of a micro-valve, incorporated in the coupling or plug will automatically release any residual pressure on reconnection.

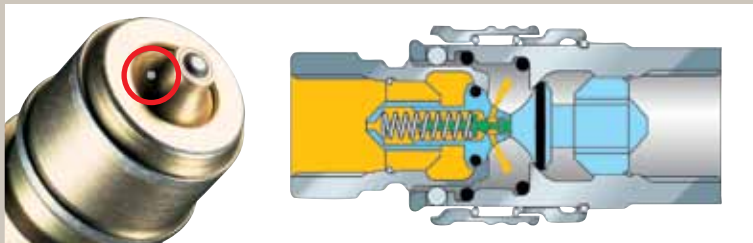

## The Pressure Relief Valve

A pressure relief valve mounted directly in the pressurised line will release the dynamic pressure in this hydraulic system by pushing a button. Attached couplings can now be coupled pressure-free! After connection, release the button to re-pressurise.

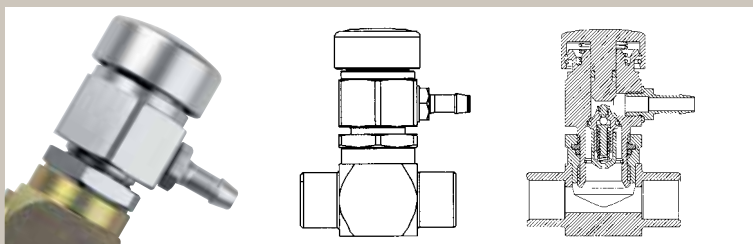

## Lubrication Nipple

The Tema lubrication nipple is a vital accessory item in order to prevent dirt to enter into couplings in disconnected position. It will also prevent freezing up of the coupling mechanism. The nipple is simple to use, just connect onto coupling body and you can easily protect internal mechanical parts using a standard grease-gun. A valuable accessory item in many climate zones.





### O-Rings / Profile rings

Depending on the application, couplings are equipped with seals in various alternative material qualities, e.g. NBR, FKM, EPDM or PUR. In many ranges, double O-ring seals are even used as standard in order to increase safety.



ISO 7241-1, A Series



ISO 7241-1, B Series



ISO 16028

### ISO-Profiles

In order to offer maximum interchangeability, our ISO A-Series (s. p. 14), ISO-B Series (s. p. 26) and ISO F-Series (s. p. 36) have been designed to conform to the latest international ISO-specifications. This will ensure full compatibility with all standard couplings and plugs which conform to the same specifications.



Steel

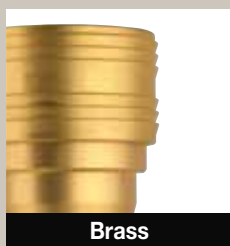

Brass



Stainless Steel

### Material Qualities

Depending on working pressures and applications, Parker coupling systems are being offered in hardened steel or brass. In addition, numerous series can be supplied as standard in stainless steel.



Zinc pl., pass., sealed



Chrome III plated



additional sealed



nitrocarburised

### Surface Finish

**Galvanised, passivated and sealed:** to prevent corrosion.

**Nitrocarburisation:** a surface hardening. The product acquires a black colour.

# FLUID COMPATIBILITY CHART

## IN ALPHABETICAL ORDER

The following seal compound and body material compatibility chart is provided as an aid in selecting a specific synthetic rubber compound or body material for a particular application. Shown here is a list of the seal materials available, with

their temperature ranges. Operating and environmental conditions must be considered when making the selection of a quick coupling. For recommendations for media not listed here, please contact your Parker representative.

Media	Body Material				Seal Material			
	Brass	Steel	AISI 316	AISI 303	NBR	EPDM	FKM	CR
3M FC -75	4	4	4	4	1	1	2	1
Acetamide	4	4	1	2	1	1	3	1
Acetic acid (5%)	3	3	1	1	2	1	1	1
Acetone	1	2	1	1	3	1	3	3
Acetophenone	2	2	2	1	3	1	3	3
Acetyl acetone	2	2	2	2	3	1	3	3
Acetyl chloride	4	2	2	2	3	3	1	3
Acetylene	3	2	1	1	1	1	1	2
Air (100 °C)	1	2	1	1	1	1	1	1
Air (150 °C)	1	2	1	1	2	2	1	2
Air (200 °C)	1	2	1	1	3	3	1	3
Aluminium acetate	4	4	4	4	2	1	3	2
Aluminium bromide	4	4	4	4	1	1	1	1
Aluminium chloride (10%)	3	3	3	3	1	1	1	1
Aluminium chloride (100%)	3	2	2	2	1	1	1	1
Aluminium fluoride	3	3	3	3	1	1	1	1
Aluminium nitrate	3	3	2	2	1	1	1	1
Aluminium salts	4	4	4	4	1	1	1	1
Aluminium sulphate	2	3	2	3	1	1	1	1
Alums (NH <sub>3</sub> , Cr, K)	4	4	4	4	1	1	3	1
Ammonia (anhydrous)	3	2	1	1	2	1	3	1
Ammonia (cold, gas)	3	2	4	1	1	1	3	1
Ammonia (hot, gas)	3	2	4	1	3	2	3	2
Ammonium carbonate	3	2	3	3	3	1	1	1
Ammonium chloride	3	3	2	3	1	1	1	1
Ammonium hydroxide	3	3	1	2	3	1	3	1
Ammonium nitrate	3	3	1	1	1	1	4	1
Ammonium persulfate solution	3	3	1	2	3	1	4	4
Ammonium phosphate (Mono-, Di-, Tri-basic)	3	3	3	2	1	1	4	1
Ammonium salts	4	4	4	4	1	1	3	1
Ammonium sulphate	3	3	2	3	1	1	3	1
Amyl borate	4	4	4	4	1	3	1	1
Amyl chloride	4	2	1	1	4	3	1	3
Amyl chloronaphthalene	4	4	4	4	3	3	1	3
Amyl naphthalene	4	4	4	4	3	3	1	3
Animal oil (lard oil)	2	2	2	2	1	2	1	2
Aroclor 1248	2	3	3	3	3	2	1	3
Aroclor 1254	2	3	3	3	3	2	1	3
Aroclor 1260	2	3	3	3	1	4	1	1
Aromatic fuel -50%	4	4	4	4	2	3	1	3
Arsenic acid	3	3	1	1	1	1	1	1
Asphalt	3	3	1	1	2	3	1	2
ASTM oil, n° 1	1	1	1	1	1	3	1	1
ASTM oil, n° 2	1	1	1	1	1	3	1	2
ASTM oil, n° 3	1	1	1	1	1	3	1	3
ASTM oil, n° 4	1	1	1	1	2	3	1	3
ASTM reference fuel A	3	2	1	1	1	3	1	2
ASTM reference fuel B	3	2	1	1	1	3	1	3
ASTM reference fuel C	3	2	1	1	2	3	1	3
Automotive brake fluid	4	4	4	4	3	1	3	2
Barium chloride	3	3	2	3	1	1	1	1
Barium hydroxide	3	2	2	3	1	1	1	1
Barium salts	4	4	4	4	1	1	1	1
Barium sulphide	3	2	3	3	1	1	1	1

**Codes:**

- 1 = satisfactory  
 2 = fair  
 3 = not recommended  
 4 = insufficient data available

Seal Material	Temperature Range
NBR	-40°C up to +110°C
EPDM	-50°C up to +150°C
FKM	-25°C up to +200°C
CR	-50°C up to +150°C

Media	Body Material				Seal Material			
	Brass	Steel	AISI316	AISI303	NBR	EPDM	FKM	CR
Beer	3	3	1	1	1	1	1	1
Beet sugar liquors	3	3	1	1	1	1	1	2
Benzaldehyde	3	3	2	3	3	1	3	3
Benzene	3	2	3	3	3	3	1	3
Benzenesulfonic acid (10%)	3	3	3	3	3	3	1	2
Benzine	4	4	4	4	1	3	1	2
Benzoic acid	3	3	3	3	3	3	1	3
Benzyl alcohol	4	3	1	2	3	2	1	2
Benzyl chloride	3	3	2	3	3	3	1	3
Bleach liquor	4	4	4	4	3	1	1	2
Borax	3	2	3	3	2	1	1	3
Bordeaux mixture	4	4	4	4	2	1	1	2
Boric acid	3	3	2	3	1	1	1	1
Brake fluid (non-petroleum)	2	2	4	4	3	1	3	2
Brine (sodium chloride)	3	3	1	1	1	1	1	1
Bromine	4	4	4	4	3	3	1	3
Bromine water	4	4	4	4	3	2	1	3
Bunker oil	4	4	4	4	1	3	1	3
Butadiene (monomer)	3	2	1	2	3	3	1	3
Butane	3	1	1	1	1	3	1	1
Butane (2,2 & 2,3-dimethyl)	4	4	4	4	1	3	1	2
Butanol (butyl alcohol)	2	1	1	1	1	2	1	1
Butter (animal fat)	2	3	1	2	1	1	1	2
Butyl butyrate	4	4	4	4	3	1	1	3
Butyl stearate	4	4	4	4	2	3	1	3
Calcine liquors	4	4	4	4	1	1	1	4
Calcium acetate	4	4	4	4	2	1	3	2
Calcium bisulphite	3	3	2	3	2	1	2	2
Calcium carbonate	3	2	3	2	1	1	1	1
Calcium chloride	3	3	2	3	1	1	1	1
Calcium hydroxide	3	3	2	3	1	1	1	1
Calcium hypochlorite	3	3	2	3	2	1	1	2
Calcium salts	4	4	4	4	1	1	1	1
Calcium sulphide	3	3	2	2	1	1	1	1
Caliche liquors	4	4	4	4	1	1	1	1
Cane sugar liquors	4	2	1	1	1	1	1	1
Carbon bisulphide	4	4	4	4	3	3	1	3
Carbon dioxide	1	2	1	1	1	1	1	1
Carbon disulfide	2	2	2	2	3	3	1	3
Carbon monoxide	1	1	1	1	1	1	1	2
Carbon tetrachloride	2	3	1	3	2	3	1	3
Carbon acid	3	3	1	2	2	1	1	1
Castor oil	1	1	1	1	1	2	1	1
Cellugard	4	4	4	4	1	1	1	1
Cellulube (now fyrquel)	4	4	4	4	3	1	1	3
China wood oil (Tung oil)	2	2	1	1	1	3	1	2
Chlorinated salt brine	4	4	4	4	3	3	1	3
Chlorinated solvents	4	4	4	4	3	3	1	3
Chlorobenzene	3	3	2	3	3	3	1	3
Chlorobutadiene	4	4	4	4	3	3	1	3
Chloroform	3	2	2	1	3	3	1	3
Chlorophenol	4	4	4	4	3	3	1	3
Coconut oil	4	4	4	4	1	3	1	3
Copper chloride	4	4	4	4	1	1	1	2



# FLUID COMPATIBILITY CHART IN ALPHABETICAL ORDER

Media	Body Material				Seal Material			
	Brass	Steel	AISI316	AISI303	NBR	EPDM	FKM	CR
Copper salts	4	4	4	4	1	1	1	1
Copper sulphate	3	3	2	3	1	1	1	1
Corn oil	2	1	1	1	1	3	1	3
Cottonseed oil	3	2	1	2	1	3	1	3
Creosols	3	2	1	2	3	3	1	3
Creosote	3	3	2	1	1	3	1	2
Cresylic acid	4	2	1	2	3	3	1	3
Crude oil	3	2	1	1	2	3	1	3
Cutting oil	4	1	1	1	1	3	1	2
Decane	4	4	4	4	1	3	1	3
Denatured alcohol	4	4	4	4	1	1	1	1
Detergent (water solution)	3	3	1	1	1	1	1	2
Diesel fuel	1	1	1	1	1	3	1	3
Diethylene glycol	3	1	1	1	1	1	1	1
Dimethyl formamide	4	4	1	1	2	1	3	3
Dow chemical HD50-4	4	4	4	4	4	1	3	2
Dow corning 200, 510, 550	4	4	4	4	2	1	1	1
Dowtherm A, E	3	1	2	2	3	3	1	3
Ethanol	1	3	3	3	3	1	3	1
Ethyl chloride	2	3	1	3	1	3	1	3
Ethyl hexanol	4	4	4	4	1	1	1	1
Ethylene dichloride	3	3	1	2	3	3	1	3
Ethylene glycol	2	2	1	2	1	1	1	1
Fatty acids	3	3	1	2	2	3	1	2
Freon 11	1	4	4	4	2	3	2	3
Freon 12	1	1	3	1	2	3	1	1
Freon 22	1	3	1	1	3	3	3	1
Fuel oil	3	1	1	1	1	3	1	2
Gallic acid	3	3	2	2	2	2	1	2
Gas, liquid, propane (LPG)	1	3	1	1	1	3	1	2
Gas, natural	2	3	1	1	1	3	1	1
Gasoline / petrol	1	2	1	1	1	3	1	3
Gelatine	3	3	1	1	1	1	1	1
Glucose	1	1	1	1	1	1	1	1
Glycerine (glycerol)	2	1	1	1	1	1	1	1
Glycols	3	2	2	2	1	1	1	1
Green sulphate liquor	3	3	3	3	2	1	1	2
Gulf – FR fluid emulsion	4	4	4	4	1	3	1	2
Gulf – FR fluid G	4	4	4	4	1	1	1	1
Gulf – FR fluid P	4	4	4	4	3	2	2	3
Helium	1	1	1	1	1	1	1	1
Heptane	1	1	1	1	1	3	1	2
Hydraulic oil (petroleum base)	1	1	1	1	1	3	1	1
Hydraulic oil (water base)	4	1	1	1	2	1	3	2
Hydrazine	4	3	1	1	2	1	3	2
Hydrogen gas	2	2	1	1	1	1	1	1
Hydrolube	4	4	4	4	1	1	1	2
Iso octane	1	1	1	1	1	3	1	2
Isobutyl alcohol	4	4	1	1	2	1	1	1
Isopropyl alcohol	1	1	2	1	2	1	1	2
Isopropyl ether	1	1	1	1	2	3	3	3
JP3 and JP4	1	1	1	1	1	3	1	3
Kerosene	1	1	1	1	1	3	1	2
Lard (animal fat)	1	1	1	1	1	2	1	2
Linseed oil	3	1	1	1	1	3	1	3
Lubricating oil SAE 10, 20, 30, 40,50	1	1	1	1	1	3	1	2
Magnesium salts	4	4	4	4	1	1	1	1
Magnesium sulphate	3	3	2	2	1	1	1	1
Mercury	3	3	1	1	1	1	1	1
Methane	1	3	1	1	1	3	1	2
Methanol	1	1	1	1	1	1	3	1
Methyl bromide	4	1	1	1	2	3	1	3

Media	Body Material				Seal Material			
	Brass	Steel	AISI316	AISI303	NBR	EPDM	FKM	CR
Methyl chloride (wet)	1	3	1	3	3	3	1	3
Methyl chloride (dry)	2	3	1	1	3	3	1	3
Methyl ether	4	4	4	4	1	3	1	3
Methyl ethyl ketone (MEK)	1	1	1	1	3	1	3	3
MIL-F81912 (JP-9)	1	1	1	1	3	3	1	3
MIL-H-5606	1	1	1	1	1	3	1	2
MIL-H-6083	1	1	1	1	1	3	1	1
MIL-H-7083	1	1	1	1	1	1	2	2
MIL-H-8446 (MLO-8515)	2	1	1	1	2	3	1	1
MIL-L-2104 & 2104B	1	1	1	1	1	3	1	2
MIL-L-7808	3	2	1	1	2	3	1	3
Milk	2	1	1	1	1	1	1	1
Mineral oils	1	1	1	1	1	3	1	2
MLO-7277 and MLO-7557	2	1	1	1	3	3	1	3
Mobile HF	1	1	1	1	1	3	1	2
Monomethyl hydrazine	4	4	4	4	2	1	4	2
Naphtha (coal or petroleum)	2	1	2	2	2	3	1	3
Naphthalene	2	1	2	2	3	3	1	3
Naphthenic acid	2	1	2	2	2	3	1	3
Neatsfoot oil	4	4	4	4	1	2	1	3
Nickel acetate	3	2	1	1	2	1	3	2
Nickel chloride	3	3	2	2	1	1	1	2
Nickel salts	4	4	4	4	1	1	1	2
Nickel sulphate	3	3	1	1	1	1	1	1
Nitrogen	1	1	1	1	1	1	1	1
Nitrous oxide	2	2	2	1	1	4	4	4
Octyl alcohol	1	1	1	1	2	3	1	2
Olive oil	2	1	1	1	1	2	1	2
Ortho-dichlorobenzene	2	2	2	2	3	3	1	3
Oxalic acid	3	3	2	1	2	1	1	2
Oxygen (100-200 °C)	1	1	1	1	3	3	2	3
Oxygen (cold)	1	1	1	1	2	1	1	1
Ozone	3	3	1	1	3	1	1	3
Palmitic acid	1	2	1	1	1	2	1	2
Para-dichlorobenzene	2	1	1	2	3	3	1	3
Parker O-Lube	1	1	1	1	1	3	1	1
Peanut oil	2	1	1	1	1	3	1	3
Pentane (2-3 methyl & 2-4 dimethyl)	2	2	2	2	1	3	1	2
Perchloric acid - 2N	3	3	2	2	3	2	1	2
Perchloroethylene	3	2	2	2	2	3	1	3
Petrolatum	1	1	1	1	1	3	1	2
Petroleum oil (below 120 °C)	1	1	1	1	1	3	1	2
Phenol	1	1	1	1	3	3	1	3
Phosphoric acid (3 molar)	3	3	2	2	1	1	1	2
Phosphoric acid (concentrated)	3	3	2	2	3	1	1	3
Phosphorous trichloride	3	3	1	1	3	1	1	3
Picric acid (molten)	3	3	2	2	2	2	1	2
Picric acid (water solution)	3	3	2	2	1	1	1	1
Pine oil	2	2	1	2	1	3	1	3
Plating solutions (chrome)	1	3	1	1	4	1	1	3
Plating solutions (other)	4	1	1	1	1	1	1	3
Pneumatic service	1	1	1	1	1	1	1	1
Potassium acetate	2	1	2	2	2	1	3	2
Potassium chloride	3	3	1	2	1	1	1	1
Potassium cyanide	3	2	2	2	1	1	1	1
Potassium dichromate	3	1	2	2	1	1	1	1
Potassium hydroxide (50%)	3	2	1	2	2	1	3	2
Potassium nitrate	2	1	1	1	1	1	1	1
Potassium salts	4	4	4	4	1	1	1	1
Potassium sulphate	3	2	1	1	1	1	1	1
PRL - high temp. hydr. oil	4	4	4	4	2	3	1	2
Producer gas	2	1	1	1	1	3	1	2

# FLUID COMPATIBILITY CHART

## IN ALPHABETICAL ORDER

Media	Body Material				Seal Material			
	Brass	Steel	AISI316	AISI303	NBR	EPDM	FKM	CR
Propane	1	3	1	1	1	3	1	2
Propyl acetate	3	1	1	1	3	2	3	3
Propyl alcohol	1	1	1	1	1	1	1	1
Propylene	1	1	1	1	3	3	1	3
Pydraul 10E	3	1	1	1	3	1	3	3
Pydraul A-200 (C series)	3	1	1	1	3	3	1	3
Pydraul (3 series)	3	1	1	1	3	1	1	3
Pyrogard 42, 43, 53, 55 (phosphate ester)	4	4	4	4	3	1	1	3
Pyrogard D	4	4	4	4	1	3	3	2
Sea water (salt water)	2	3	1	1	1	1	1	2
Shell irus 905	4	4	4	4	1	3	1	2
Silicone greases	1	1	1	1	1	1	1	1
Silver nitrate	3	3	1	2	2	1	1	1
Skydrol 500 (type 2)	3	1	1	1	3	1	3	3
Skydrol 7000 (type 2)	3	1	1	1	3	1	2	3
Soap solutions	3	3	1	1	1	1	1	2
Sodium acetate	1	1	1	1	2	1	3	2
Sodium bicarbonate	2	2	1	1	1	1	1	1
Sodium bisulphate or bisulphite	3	3	2	1	1	1	1	1
Sodium borate	3	2	2	2	1	1	1	1
Sodium carbonate	4	1	1	1	1	1	1	1
Sodium chloride	3	2	2	2	1	1	1	1
Sodium cyanide	3	1	1	1	1	1	4	1
Sodium hydroxide	3	2	1	2	2	1	2	2
Sodium hydroxide (50%)	3	3	1	2	2	1	2	2
Sodium metaphosphate	2	1	2	2	1	1	1	2
Sodium nitrate	3	2	1	1	2	1	4	2
Sodium perborate	3	3	1	1	2	1	1	2
Sodium peroxide	3	1	2	2	2	1	1	2
Sodium phosphates	1	3	2	1	1	1	1	2
Sodium salts	4	4	4	4	1	1	1	2
Sodium sulphate	3	2	1	1	1	1	1	1
Sodium sulphite & sulphide	3	3	2	3	1	1	1	1
Sodium thiosulphate	3	3	1	2	2	1	1	1
Soybean oil	2	1	1	1	1	3	1	3
Stannous chloride (15 %)	3	3	2	3	1	1	1	1
Steam (below 200 °C)	1	3	1	1	3	1	3	3
Stoddard solvents	2	1	1	1	1	3	1	2
Sucrose solutions	1	1	1	1	1	1	1	2
Sulphur	2	1	1	1	3	1	1	1
Sulphur liquors	1	1	1	1	2	2	1	2
Sulphur (molten)	3	3	1	1	3	3	1	3
Sulphur dioxide (dry)	3	1	1	3	3	1	3	3
Sulphur trioxide (dry)	2	2	2	3	3	2	1	3
Sunsafe	3	1	1	1	1	3	1	2
Tannic acid (10%)	1	3	2	3	1	1	1	2
Tar (bituminous)	2	1	1	1	2	3	1	3
Tartaric acid	2	3	3	2	1	2	1	2
Terpineol	4	4	4	4	2	3	1	3
Tertiary butyl alcohol	1	1	1	1	2	2	1	2
Tetrachloroethane	4	2	1	2	3	3	1	3
Tetrachloroethylene	3	2	2	4	3	3	1	3
Tetraethyl lead	1	1	1	1	2	3	1	2
Tetraethyl lead (blend)	1	1	1	1	2	3	1	3
Titanium tetrachloride	2	1	2	3	2	3	1	3
Toluene	1	1	1	1	3	3	1	3
Transformer oil	1	1	1	1	1	3	1	2
Transmission fluid (type A)	1	1	1	1	1	3	1	2
Trichloroethane	4	2	1	4	3	3	1	3
Trichloroethylene	3	2	2	2	3	3	1	3
Tricresyl phosphate	4	1	2	2	3	1	2	3
Turbine oil #15 (MIL-L-7808A)	4	2	1	1	2	3	1	3

Media	Body Material				Seal Material			
	Brass	Steel	AISI316	AISI303	NBR	EPDM	FKM	CR
Varnish	1	1	1	1	2	3	1	3
Water	1	3	1	1	1	1	2	2
Whiskey	1	3	1	1	1	1	1	1
Wine	1	3	1	1	1	1	1	1
Wood oil	4	2	1	1	1	3	1	2
Xylene	1	2	1	1	3	3	1	3
Zinc sulphate	3	3	2	2	1	1	1	1

**Note:** This chart is intended as a guide only and is not to be considered as a recommendation to use Parker quick couplings in a specific application or with a specific fluid. Other factors that must be considered include but are not limited to: fluid and ambient temperature, system pressure, both operating and peaks, frequency of connection and disconnection, and applicable standards or regulations.

# SAFETY GUIDE FOR SELECTING AND USING QUICK CONNECT COUPLINGS AND RELATED ACCESSORIES

**DANGER:** failure or improper selection or improper use of quick connect couplings or related accessories can cause death, personal injury and property damage. Possible consequences of failure or

improper selection or improper use of quick connect couplings or related accessories include but are not limited to:

- Couplings or parts thrown off at high speed
- High velocity fluid discharge
- Contact with suddenly moving or falling objects that are to be held in position or moved by the conveyed fluid
- Dangerously whipping hose

Before selecting or using any Parker RectusTema quick connect couplings or related accessories, it is important that you read and follow the following instructions.

## 1.0 GENERAL INSTRUCTIONS

**1.1 Scope:** this catalogue provides instructions for selecting and using (including installing connecting, disconnecting, and maintaining) quick connect couplings and related accessories (including caps, plugs, hoses, blow guns). This safety instruction is a supplement to and is to be used with the specific Parker publications for the specific quick connect couplings and related accessories that are being considered for use.

**1.2 Fail-Safe:** quick connect couplings or the hose they are attached to can fail without warning for many reasons. Design all systems and equipment in a fail-safe mode, so that failure of the quick connect coupling or hose will not endanger persons or property.

**1.3 Distribution:** provide a copy of this safety guide to each person who is responsible for selecting or using quick connect coupling products. Do not select or use quick connect couplings without thoroughly reading and understanding this safety guide as well as the specific Parker publications for the products considered or selected.

**1.4 User responsibility:** due to the wide variety of operating conditions and uses for quick connect couplings, Parker RectusTema and its distributors do not represent or warrant that any particular coupling system is suitable for any specific end use system. This safety instructions do not analyse all technical parameters that must be considered in selecting a product. The user, through its own analysis and testing, is solely responsible for:

- Making the final selection of the quick connect couplings.
- Assuring that the user's requirements are met and that the use presents no health or safety hazards.
- Providing all appropriate health and safety warnings on the equipment on which the quick connect couplings are used.

**1.5 Additional questions:** call the appropriate Parker customer service department if you have any questions or require any additional information. For the telephone numbers of the appropriate customer service department, see the Parker publication for the product being considered or used.

## 2.0 SELECTION INSTRUCTIONS

**2.1 Pressure:** quick connect couplings selection must be made so that the published rated pressure of the coupling is equal to or greater than the maximum system pressure. Pressure surges in the system higher than the rated pressure of the coupling will shorten the quick connect coupling's life. Do not confuse burst pressure or other pressure values with rated pressure and do not use burst pressure or other pressure values for this purpose.

**2.2 Fluid compatibility:** quick connect couplings selection must assure compatibility of the body and seal materials with the fluid media used. See the fluid compatibility chart.

**2.3 Temperature:** be certain that fluid and ambient temperatures, both steady and transient, do not exceed the limitations of the quick connect couplings. Use caution and hand protection when connecting or disconnecting quick connect couplings that are heated or cooled by the media they are conducting or by their environment.

**2.4 Size:** transmission or power by means of pressurised liquid varies with pressure and rate of flow. The size of the quick connect couplings and other components of the system must be adequate to keep pressure losses to a minimum and avoid damage due to heat generation or excessive fluid velocity.

**2.5 Pressurised connection or disconnection:** if connecting or disconnecting under pressure is a requirement, use only quick connect couplings designed for that purpose. The rated operating pressure of a quick connect coupling may not be the pressure at which it may be safely connected or disconnected.

**2.6 Environment:** care must be taken to ensure that quick connect couplings are either compatible with or protected from the environment (that is, surrounding conditions) to which they are exposed. Environmental conditions including but not limited to ultraviolet radiation, ozone, moisture, water, salt water, chemicals, and air pollutants can cause degradation and premature failure.





**2.7 Locking means:** ball locking quick connect couplings can unintentionally disconnect if they are dragged over obstructions on the end of a hose or if the sleeve is bumped or moved enough to cause disconnection. Sleeves designed with flanges to provide better gripping for oily or gloved hands are especially susceptible to accidental disconnection and should not be used where these conditions exist. Sleeve lock or union (threaded) sleeve designs should be considered where there is a potential for accidental uncoupling.

**2.8 Mechanical loads:** external forces can significantly reduce quick connect couplings' life or cause failure. Mechanical loads which must be considered include excessive tensile or side loads and vibration. Unusual applications may require special testing prior to quick connect couplings selection.

**2.9 Specifications and standards:** when selecting quick connect couplings, government, industry and Parker specifications must be reviewed and followed as applicable.

**2.10 Vacuum:** not all quick connect couplings are suitable or recommended for vacuum service. Quick connect couplings used for vacuum applications must be selected to ensure that the quick connect couplings will withstand the vacuum and pressure of the system.

**2.11 Fire resistant fluids:** some fire resistant fluids require seals other than the standard NBR (nitrile) used in many coupling systems.

**2.12 Radiant heat:** quick connect couplings can be heated to destruction or loss of sealing without contact by such nearby items as hot manifolds or molten metal. The same heat source may then initiate a fire. This can occur despite the presence of cool air around the quick connect couplings.

**2.13 Welding and brazing:** heating of plated parts, including quick connect couplings and port adapters, above 450 °F (232 °C) such as during welding, brazing, or soldering may emit deadly gases and may cause coupling seal damage.

### 3.0 INSTALLATION INSTRUCTIONS

**3.1 Pre-installation inspection:** before installing a quick connect coupling, visually inspect it and check for correct style, body material, seal material, and catalogue number. Before final installation, coupling halves should be connected and disconnected with a sample of the mating half with which they will be used.

**3.2 Quick connect coupling halves from other manufacturers:** if a quick connect coupling assembly is made up of one Parker RectusTema half and one half from another manufacturer, the lowest pressure rating of the two halves should not be exceeded.

**3.3 Fitting installation:** use a thread sealant, when assembling taper pipe thread joints in quick connect couplings. Be sure the sealant is compatible with the system fluid or gas. To avoid system contamination, use a liquid or paste type sealant rather than a tape style. Use the flats provided to hold the quick connect coupling when installing fittings. Do not use pipe wrenches or a vice on other parts of the coupling to hold it when installing or a removing fittings as damage or loosening of threaded joints in the coupling assembly could result. Do not apply excessive torque to taper pipe threads because cracking or splitting of the female component can result.

**3.4 Caps and plugs:** use dust caps and plugs when quick connect couplings are not coupled to exclude dirt and contamination and to protect critical surfaces from damage.

**3.5 Coupling location:** locate quick connect couplings where they can be reached for connection or disconnection without exposing the operator to slipping, falling, getting sprayed or coming in contact with hot or moving parts.

**3.6 Hose whips:** use a hose whip (a short length of hose between the tool and the coupling half) instead of rigidly mounting a coupling half on hand tools or other devices. This reduces the potential for coupling damage if the tool is dropped and provides some isolation from mechanical vibration which could cause uncoupling.

### 4.0 MAINTENANCE INSTRUCTIONS

**4.1** Even with proper selection and installation, quick connect coupling life may be significantly reduced without a continuing maintenance program. Frequency should be determined by the severity of the application and risk potential. A maintenance program must be established and followed by the user and must include the following as a minimum:

**4.2 Visual inspection of quick connect couplings:** any of the following conditions require immediate shut down and replacement of the quick connect coupling:

- Cracked, damaged, or corroded quick connect couplings parts.
- Leaks at the fitting, valve or mating seal.
- Broken coupling mounting hardware, especially breakaway clamps.

**4.3 Visual inspection all other:**

- Leaking seals or port connections.
- Excess dirt build-up on the coupling locking means or on the interface area of either coupling half.
- Defective clamps, guards, and shields.
- System fluid level, fluid type and any entrapment.

**4.4 Functional test:** operate the system at maximum operating pressure and check for possible malfunctions and freedom from leaks. Personnel must avoid potential hazardous areas while testing and using the system.

**4.5 Replacement intervals:** specific replacement intervals must be considered based on previous service life, government or industry recommendations, or when failures could result in unacceptable downtime, damage or injury risk. See instruction 1.2 above.



Body Size

1/4" up to 1"

ISO A-Series

6600-Series

Medium Pressure



**Technical Description**

The series 6600 couplings meet the requirements and dimensions of the ISO 7241-1 A standard.

**Advantages**

NBR seals and back-up ring in PTFE to withstand flow surges at high flow rates. Single acting sleeve. Connection and disconnection are possible by pulling the sleeve. Poppet valving. Chrome 6 free plated steel.

**Applications**

- Used for a wide range of agricultural applications
- Mobile and construction equipment
- In-plant machinery including hydraulic power units and hand tools

**Working Pressure**

1/4"	350 bar
3/8"	280 bar
1/2"	280 bar
3/4"	280 bar
1"	280 bar

**Working Temperature**

-40°C up to + 110°C (NBR) depending on the medium. Special seals are available on request (see page 6 ff).

**Applications Area**



Material Coupling	Standard
Coupling Body	Steel
Sleeve	Steel
Back-up Ring	PTFE
Valve	Steel
Springs	Stainless Steel
Locking Balls	Steel
Seals	NBR
Valve Holder	Stainless Steel
Material Plug	Standard
Plug Body	Steel
Valve	Steel
Springs	Stainless Steel
Seals	NBR
Valve Holder	Stainless Steel

**Flow Capacity with Oil with Viscosity of 43cSt at 38°C as per ISO 7241/2-2000**

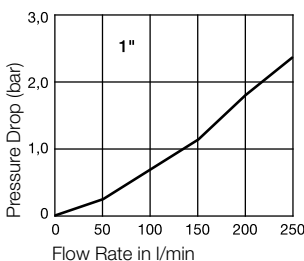
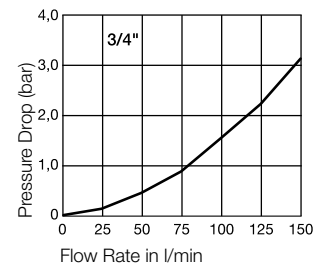
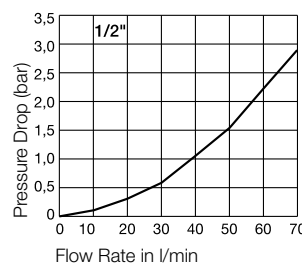
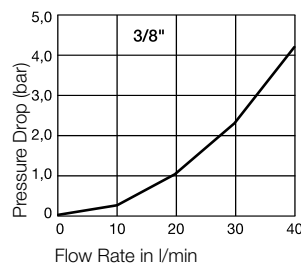
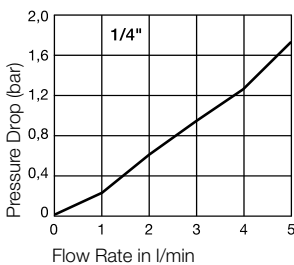

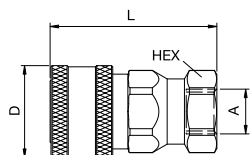
**Couplings****6600-Series**

Female BSPP Thread

Body Size	Connection A	Hex mm	L mm	D mm	D1 mm	Weight gr.	Max. Operating Pressure	Part Number
1/4"	1/4"	22	49	27		123	350 bar	6603-4-4
3/8"	3/8"	27	56	31,8		180	280 bar	6603-6-6
1/2"	1/2"	32	71	38,1		309	280 bar	6603-8-10
3/4"	3/4"	41	85,5	47,6		624	280 bar	6603-12-12
1"	1"	48	104	54		842	280 bar	6603-16-16

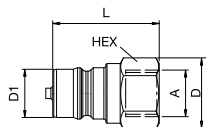
**Plugs****6600-Series**

Female BSPP Thread

Body Size	Connection A	Hex mm	L mm	D mm	D1 mm	Weight gr.	Max. Operating Pressure	Part Number
1/4"	1/4"	19	34,5	22	11,8	39	350 bar	6605-4-4
3/8"	3/8"	22	38,1	25,5	17,2	55	280 bar	6605-6-6
1/2"	1/2"	27	49,3	31	20,5	97	280 bar	6605-8-10
3/4"	3/4"	35	57,9	40,3	29	217	280 bar	6605-12-12
1"	1"	41	70,5	47,5	34,3	330	280 bar	6605-16-16

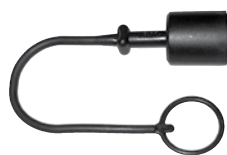
**Dust Protection****6600-Series**

Body Size	Version	Color	Part Number
1/4"	for coupling	Red	6659-4PL
3/8"	for coupling	Red	6659-6PL
1/2"	for coupling	Red	6659-8PL
3/4"	for coupling	Red	6659-12PL
1"	for coupling	Red	6659-16PL
1/4"	for plug	Red	6657-4PL
3/8"	for plug	Red	6657-6PL
1/2"	for plug	Red	6657-8PL
3/4"	for plug	Red	6657-12PL
1"	for plug	Red	6657-16PL

**Seal-Kit****6600-Series**

Body Size	Version	Material	Part Number O-Ring	Part Number Back-up Ring
1/4"	universal	NBR	020112N0674	4118006
3/8"	universal	NBR	JT020115N0674	4118005
1/2"	universal	NBR	JT020211N0674	50-140-4
3/4"	universal	NBR	020123N0674	4138001
1"	universal	NBR	020126N0674	4148002



Body Size

3/8" and 1/2"

ISO A-Series

2000-Series

Medium Pressure



**Technical Description**

Meets the requirements of ISO 7241-1-A. Modular construction: broad choice of end configurations (variety of threads - BSPP and metric). Two valve options: Poppet or ball valving. Push-Pull connection- / disconnection.

**Advantages**

Can be connected with other products complying with the same standard. NBR seals and back-up ring in PTFE to

withstand flow surges at high flow rates. Double acting sleeve (Push-Pull). Ball or three-part poppet style valving with a molded shaped seal to prevent seal washout at high flow rates. Chrome 6 free plating.

**Applications**

- Used for a wide variety of agricultural applications
- Mobile and construction equipment
- Industrial equipment

**Working Pressure**

Poppet valve  
3/8" 315 bar  
1/2" 250 bar  
Ball valving  
1/2" 210 bar

**Working Temperature**

-25°C up to +110°C (NBR) depending on the medium.

**Applications Area**



Material Coupling	Standard
Valve Body	Steel, silver plated
Sleeve	Steel, hardened, silver plated
Back-up Ring	PTFE
Valve	Steel, silver plated
Springs	Steel
Locking Balls	Steel
Seals	NBR
Valve Holder	Steel
Back Body	Steel, silver plated
Material Plug	Standard
Plug Body	Steel hardened, silver plated
Valve	Steel, silver plated
Springs	Steel
Seals	NBR
Valve Holder	Steel, silver plated

**Flow Capacity with Oil with Viscosity of 43cSt at 38°C as per ISO 7241/2-2000**

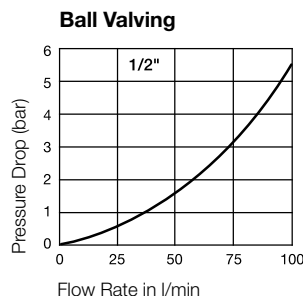
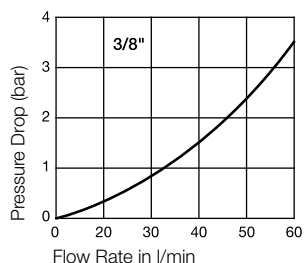
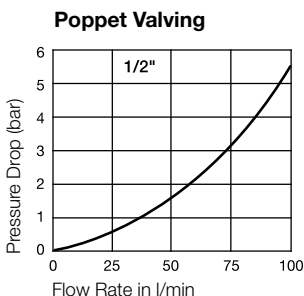

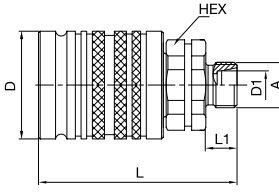
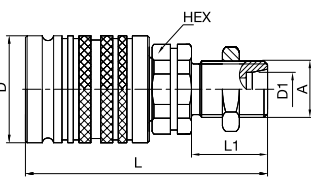
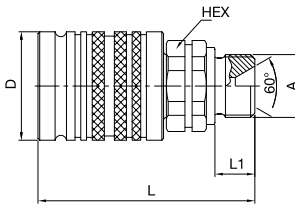
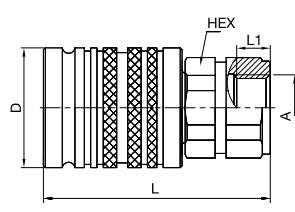
	Body Size	Connection A	Tube O/D D1/mm	Hex mm	L mm	L1 mm	D mm	Max. Operating Pressure	Weight gr.	Version	Part Number
 <p>Male thread 24° cone – DIN 2353</p>	3/8"	M 14 x 1,5	8	22	65	10	31	315 bar	194	Light	4V53D6X2-B
	3/8"	M 16 x 1,5	10	22	66	11	31	315 bar	196	Light	4V53D6X3-B
	3/8"	M 18 x 1,5	10	22	67	11	31	315 bar	201	Heavy	4V53D7X3-B
	1/2"	M 14 x 1,5	8	30	69	10	38	250 bar	293	Light	4V54D6X2-B
	1/2"	M 16 x 1,5	10	30	70	11	38	250 bar	295	Light	4V54D6X3-B
	1/2"	M 18 x 1,5	12	30	70	11	38	250 bar	295	Light	4V54D6X4-B
	1/2"	M 22 x 1,5	15	30	71	12	38	250 bar	300	Light	4V54D6X5-B
	1/2"	M 26 x 1,5	18	30	71	12	38	250 bar	306	Light	4V54D6X6-B
	1/2"	M 18 x 1,5	10	30	71	12	38	250 bar	302	Heavy	4V54D7X3-B
	1/2"	M 24 x 1,5	16	30	73	14	38	250 bar	309	Heavy	4V54D7X6-B
 <p>Male thread 24° cone – DIN 2353 Bulkhead</p>	3/8"	M 16 x 1,5	10	22	81	26	31	315 bar	208	Light	4V53E6X3-B
	1/2"	M 14 x 1,5	8	30	85	26	38	250 bar	314	Light	4V54E6X2-B
	1/2"	M 16 x 1,5	10	30	85	26	38	250 bar	319	Light	4V54E6X3-B
	1/2"	M 18 x 1,5	12	30	85	26	38	250 bar	325	Light	4V54E6X4-B
	1/2"	M 22 x 1,5	15	30	86	27	38	250 bar	347	Light	4V54E6X5-B
	1/2"	M 26 x 1,5	18	30	86	34	38	250 bar	380	Light	4V54E6X6-B
	1/2"	M 18 x 1,5	10	30	86	27	38	250 bar	334	Heavy	4V54E7X3-B
	1/2"	M 20 x 1,5	12	30	86	27	38	250 bar	344	Heavy	4V54E7X4-B
	1/2"	M 24 x 1,5	16	30	88	29	38	250 bar	366	Heavy	4V54E7X6-B
 <p>Male thread BSPP – DIN 3852 Form B</p>	3/8"	3/8"		22	74	12	31	315 bar	195		4V53F4B3-B
	1/2"	3/8"		30	73	12	38	250 bar	327		4V54F4B3-B
	1/2"	1/2"		30	76	14	38	250 bar	311		4V54F4B4-B
 <p>Female thread – DIN 3852 Form Y</p>	3/8"	3/8"		22	67	12	31	315 bar	203		4V53G4X3-B
	1/2"	3/8"		30	72	12	38	250 bar	327		4V54G4X3-B
	1/2"	1/2"		27	70	12	38	250 bar	324		4V54G4X4-B
	1/2"	1/2"		27	70	12	38	280 bar	304	Ball Valve	4054G4X4-B
	1/2"	3/4"		36	77,5	16,5	38	250 bar	374		4V54G4X6-B
	1/2"	M 18 x 1,5		30	72	12,5	38	250 bar	322		4V54G8X5-B
	1/2"	M 22 x 1,5		30	72	14,5	38	250 bar	315		4V54G8X6-B
	1/2"	1/2" NPT		27	70	15	38	280 bar	308	Ball Valve	4054G0Z4-B







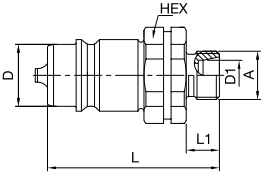
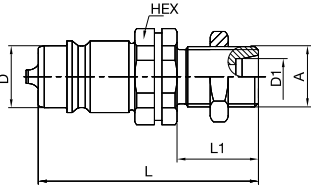
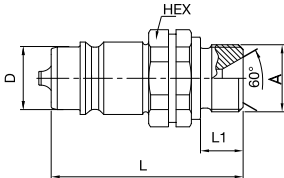
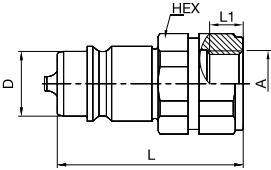

Plugs

2000-Series

	Body Size	Connection A	Tube O/D D1/mm	Hex mm	L mm	L1 mm	D mm	Max. Operating Pressure	Weight gr.	Version	Part Number
 <p>Male thread 24° cone – DIN 2353</p>	3/8"	M 14 x 1,5	8	22	47	10	17,3	315 bar	75	Light	4V13D6X2-B
	3/8"	M 16 x 1,5	10	22	48	11	17,3	315 bar	77	Light	4V13D6X3-B
	3/8"	M 18 x 1,5	10	22	49	11	17,3	315 bar	82	Heavy	4V13D7X3-B
	1/2"	M 14 x 1,5	8	30	56	10	20,5	250 bar	136	Light	4V14D6X2-B
	1/2"	M 16 x 1,5	10	30	57	11	20,5	250 bar	137	Light	4V14D6X3-B
	1/2"	M 18 x 1,5	12	30	57	11	20,5	250 bar	138	Light	4V14D6X4-B
	1/2"	M 22 x 1,5	15	30	58	12	20,5	250 bar	143	Light	4V14D6X5-B
	1/2"	M 26 x 1,5	18	30	58	12	20,5	250 bar	148	Light	4V14D6X6-B
	1/2"	M 18 x 1,5	10	30	58	12	20,5	250 bar	145	Heavy	4V14D7X3-B
	1/2"	M 24 x 1,5	16	30	60	14	20,5	250 bar	151	Heavy	4V14D7X6-B
 <p>Male thread 24° cone – DIN 2353 Bulkhead</p>	3/8"	M 16 x 1,5	10	22	63	26	17,3	315 bar	98	Light	4V13E6X3-B
	1/2"	M 14 x 1,5	8	30	72	26	20,5	250 bar	156	Light	4V14E6X2-B
	1/2"	M 16 x 1,5	10	30	72	26	20,5	250 bar	162	Light	4V14E6X3-B
	1/2"	M 18 x 1,5	12	30	72	26	20,5	250 bar	166	Light	4V14E6X4-B
	1/2"	M 22 x 1,5	15	30	73	27	20,5	250 bar	190	Light	4V14E6X5-B
	1/2"	M 26 x 1,5	18	30	73	34	20,5	250 bar	222	Light	4V14E6X6-B
	1/2"	M 18 x 1,5	10	30	73	27	20,5	250 bar	176	Heavy	4V14E7X3-B
	1/2"	M 20 x 1,5	12	30	73	27	20,5	250 bar	186	Heavy	4V14E7X4-B
	1/2"	M 24 x 1,5	16	30	75	29	20,5	250 bar	208	Heavy	4V14E7X6-B
 <p>Male thread BSPP – DIN 3852 Form B</p>	3/8"	3/8"		22	56	12	17,3	315 bar	75		4V13F4B3-B
	1/2"	3/8"		30	60	12	20,5	250 bar	146		4V14F4B3-B
	1/2"	1/2"		30	63	14	20,5	250 bar	154		4V14F4B4-B
 <p>Female thread – DIN 3852 Form Y</p>	3/8"	3/8"		22	49	12	17,3	315 bar	84		4V13G4X3-B
	1/2"	3/8"		30	59	12	20,5	250 bar	168		4V14G4X3-B
	1/2"	1/2"		27	48	12	20,5	250 bar	164		4V14G4X4-B
	1/2"	1/2"		27	48	12	20,5	280 bar	101	Ball Valve	4014G4X4-B
	1/2"	3/4"		36	64,5	16,5	20,5	250 bar	217		4V14G4X6-B
	1/2"	M 18 x 1,5		30	59	12,5	20,5	250 bar	165		4V14G8X5-B
	1/2"	M 22 x 1,5		30	59	14,5	20,5	250 bar	157		4V14G8X6-B
	1/2"	1/2" NPT		27	48	15	20,5	280 bar	104	Ball Valve	4014G0Z4-B

## Dust Protection

## 2000-Series

	Body Size	Version	Material	Color	Part Number
	3/8"	for coupling	Plastic	red	5025-3PR
	1/2"	for coupling	Plastic	see color code	5025-4P <sup>1</sup>
	3/8"	for plug	Plastic	red	5029-3PR
	1/2"	for plug	Plastic	see color code	5029-4P <sup>1</sup>
	1/2"	for coupling	Rubber	black	5205-4M
	1/2"	for plug	Rubber	black	5209-4M
	1/2"	for coupling	Steel		5005-4
	1/2"	for plug	Steel		5009-4

<sup>1</sup> Color code: B = blue/G = green/ R = red/O = orange/ Y = yellow/ BL = black

## Seal-Kit

## 2000-Series

	Body Size	Version	Material O-Ring	Material Back-up Ring	Part Number
	3/8"	universal	NBR	PTFE	4V53-KIT
	1/2"	universal	NBR	PTFE	4V54-KIT1
	1/2"	for 4V54G4X4 and 4054G4X4	NBR	PTFE	4V53-KIT2



Body Size

1/2"

ISO A-Series

RSD-Series

**Technical Description**

The RSD series has been manufactured according to the regulations and dimensions of the standard specification ISO 7241-1 A series and can be connected with other series complying with the same standard.

**Advantages**

Our one hand operated push-pull version serve to prevent leakage and destruction of the hydraulic hoses by automatic disconnection in case of accidental traction on the hose. The integrated detent system prevents circuit shut off in back-flow condition (> 240 l/min - direction male to female). The connection can be done under full system pressure in the plug.

**Working Pressure**

See charts.

**Working Temperature**

-30°C up to +110°C (NBR) depending on the medium. Special seals are available on request (see page 6 ff).

Material Coupling	Standard
Coupling Body	Chrome VI free Plated Steel
Sleeve	Chrome VI free Plated Steel
Valve	Chrome VI free Plated Steel
Springs	Steel
Locking Balls	Steel
Seals	Composite
Valve Holder	Composite

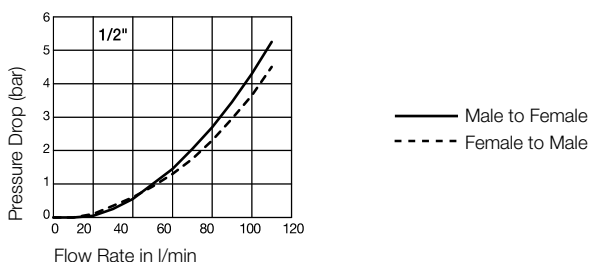
**Applications Area****Flow Capacity with Oil with Viscosity of 43cSt at 38°C as per ISO 7241/2-2000**

## Couplings

## RSD-Series

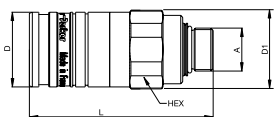
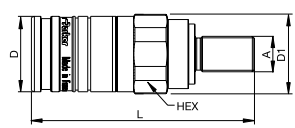
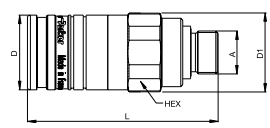
	Body Size	Connection A	Hex mm	L mm	D mm	D1 mm	Working Pressure in bar	Weight gr.	Part Number
 <p>Male Thread ISO 6149-2</p>	1/2"	M 22 x 1,5	38	94,5	38	40	250	459	RSD-501-22MM-F
 <p>Male Thread</p>	1/2"	M 18 x 1,5	38	110	38	40	250	490	RSD-501-18BMCL-F
	1/2"	M 22 x 1,5	38	110	38	40	250	510	RSD-501-22BMCL-F
 <p>Male Thread ISO 9974-2 with ED-Seal</p>	1/2"	M 22 x 1,5	38	97,5	38	40	250	480	RSD-501-22MME-F

## Dust Protection

## RSD-Series

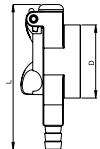
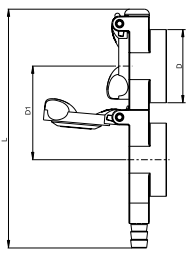
	Body Size	Version	L mm	D mm	D1 mm	Material	Color	Part Number
	1/2"	Single Dust Cap	85	43		PA6-6	Black	DCP-500 <sup>1</sup>
	1/2"	Double Dust Cap	140	43	55	PA6-6	Black	DCP-555 <sup>1</sup>
	1/2"	Double Dust Cap	157	43	72	PA6-6	Black	DCP-572 <sup>1</sup>
	1/2"	Double Dust Cap	167	43	82	PA6-6	Black	DCP-582 <sup>1</sup>

## Colored Caps for Dust Protection

## RSD-Series

	Body Size	Version	L mm	D mm	D1 mm	Material	Color	Part Number
						PA6-6	Red	9809-018-R
						PA6-6	Yellow	9809-018-J
						PA6-6	Black	9809-018-N
						PA6-6	Green	9809-018-V
						PA6-6	Blue	9809-018-B

<sup>1</sup> Colored caps are not included in the single and double dust caps but have to be ordered separately.



Body Size

1/2"

ISO-A Series

# 5500-Series

Medium Pressure



**Applications Area**



**Bursting Pressure**

Body Size	Bursting Pressure Connected
1/2"	> 1000 bar

**Technical Description**

The 5500 series has been manufactured according to the regulations and dimensions of the standard specification ISO 7241-1 A series. With the pressure eliminator, it is possible to establish connections with residual pressure (up to 200 bar). The pressure eliminator is available for both – coupling and the plug.

**Advantages**

Can be fitted with pressure eliminator to ensure effortless connection even with residual pressure.  
The unique design with brass female and rated work pressure of 250 bar.  
High flow performance (low pressure drop).

**Working Pressure**

See charts.

**Working Temperature**

-30°C up to +100°C (NBR)  
-25°C up to +200°C (FKM) depending on the medium. Special seals are available on request (see page 6 ff).

**Available Valves**



Material Coupling	Standard / Pressure Eliminator
Coupling Body	Brass
Sleeve	Brass, nickel plated
Valve	Brass hardened
Springs	AISI 301
Locking Balls	AISI 420 C
Seals	NBR/FKM
Valve Holder (up to 100°C)	Zinc Casting
Valve Holder (over 100°C)	Brass

Plug	Standard / Pressure Eliminator
Coupling Body	Steel hardened, zinc plated, passivated
Valve	Brass, hardened
Springs	AISI 301
Seals	NBR/FKM
Valve Holder (up to 100°C)	Zinc Casting
Valve Holder (over 100°C)	Brass

**Flow Capacity with Oil with Viscosity of 32cSt at 40°C as per ISO 7241/2-2000**



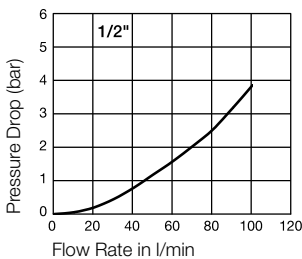

**Couplings****5500-Series**

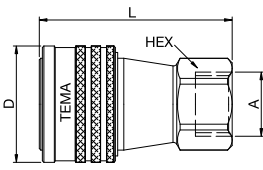
	Body Size	Connection A	Hex mm	L mm	D mm	Working Pressure connected in bar	Seal	Part Number
 <p>Female Thread</p>	1/2"	G 1/2	27	63	38	250	NBR	5510-QC
	1/2"	G 1/2	27	63	38	250	FKM	5510 V

**Plugs****5500-Series**

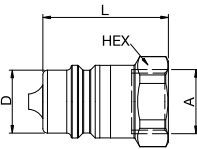
	Body Size	Connection A	Hex mm	L mm	D mm	Working Pressure connected in bar	Seal	Part Number
 <p>Female Thread</p>	1/2"	G 1/2	27	42	20	250	NBR	5520
	1/2"	G 1/2	27	42	20	250	FKM	5520 V

**Couplings****5500-Series Pressure Eliminator**

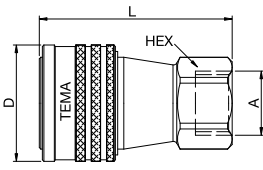
	Body Size	Connection A	Hex mm	L mm	D mm	Working Pressure connected in bar	Seal	Part Number
 <p>Female Thread</p>	1/2"	G 1/2	27	63	38	250	NBR	5511
	1/2"	G 1/2	27	63	38	250	FKM	5511 V

**Plugs****5500-Series Pressure Eliminator**

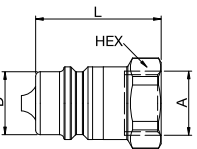
	Body Size	Connection A	Hex mm	L mm	D mm	Working Pressure connected in bar	Seal	Part Number
 <p>Female Thread</p>	1/2"	G 1/2	27	42	20	250	NBR	5521
	1/2"	G 1/2	27	42	20	250	FKM	5521 V

## Seal-Kit

## 5500-Series

Body Size	Version	Material	Part Number
1/2"	for coupling	NBR	5500-PSN
1/2"	for coupling	FKM	5500-PSV
1/2"	for coupling	EPDM	5500-PSEP

## Dust Protection

## 5500-Series

Body Size	Version	L mm	D mm	Material	Color	Part Number
1/2"	for coupling	242	30	PVC	Blue	5515-QC
1/2"	for plug	264	30	PVC	Blue	5525





Body Size

1/8" up to 2 1/2"

ISO B-Series

60 Series

Medium Pressure



**Working Pressure**

**Low Cycle, non-pulsating pressure rating**

Body Size	Steel	Stainl. Steel	Brass
1/8"	350 bar	350 bar	210 bar
1/4"	350 bar	350 bar	255 bar
3/8"	280 bar	350 bar	185 bar
1/2"	280 bar	350 bar	240 bar
3/4"	175 bar	210 bar	150 bar
1"	140 bar	210 bar	105 bar
1 1/2"	105 bar	105 bar	105 bar
2 1/2"	105 bar	-	85 bar

**ANSI/ISO Pressure Rating**

Body Size	Steel	Stainl. Steel	Brass
1/8"	350 bar	140 bar	70 bar
1/4"	350 bar	140 bar	70 bar
3/8"	280 bar	105 bar	70 bar
1/2"	280 bar	105 bar	70 bar
3/4"	175 bar	105 bar	70 bar
1"	140 bar	70 bar	70 bar
1 1/2"	70 bar	70 bar	55 bar
2 1/2"	70 bar	-	55 bar

**Technical Description**

The 60 series plug profiles conform to ISO Standard 7241-1 series B and are compatible with other series complying with the same standard.

**Advantages**

A poppet with crimped seal assures a maximum sealing at low flow rates and prevents seal washout at high flow rates. A large number of locking balls distribute the work load evenly while providing alignment for the two parts of the coupling. Steel versions feature PTFE back-up ring which prevents seal damage for high pressure applications. Brass couplers have a double O-ring seal for redundancy in low pressure and vacuum applications.

**Sleeve-Lock:**

60 series couplers are available with safety locking sleeves. Please add the suffix **SL** to the part number, e.g. **H3-62-SL**.

**Working Temperature**

-40°C up to +110°C (NBR)  
-20°C up to +200°C (FKM)  
depending on the medium. Special seals are available on request (see page 6 ff).

**Heavy Duty Nipples**

Parker 60 series heavy duty nipples are recommended for extended life in applications where high cycle rates and pressure surges are encountered. Machined from high tensile steel and specially hardened.

To specify a heavy duty nipple, add the prefix **HD** to the steel series part number, thus: **HDH2-63**.

**Applications**

- Semiconductor industry, steel manufacturing
- Pneumatic and hydraulic hand tools
- Food and bottling industry
- Boating, shipbuilding and offshore industry
- Pharmaceutical industry, laboratories
- Transport
- Power generation plants, hydroelectric power stations

Material Coupling	Brass	Steel	AISI 303	AISI 316
Coupling Body	Brass	Steel	AISI 303	AISI 316
Sleeve	Brass	Steel	AISI 303	AISI 316
Back-up Ring	Stainless Steel	Stainless Steel	Stainless Steel	Stainless Steel
Valve	Brass	Steel	AISI 303	AISI 316
Springs	Stainless Steel	Stainless Steel	Stainless Steel	Stainless Steel
Locking Balls	Stainless Steel	Stainless Steel	Stainless Steel	Stainless Steel
Seals	NBR	NBR	NBR	FKM
Valve Holder	Stainless Steel	Stainless Steel	Stainless Steel	Stainless Steel
Thread Body	Brass	Steel	AISI 303	AISI 316

Material Plug	Brass	Steel	AISI 303	AISI 316
Plug Body	Brass	Steel	AISI 303	AISI 316
Valve	Brass	Steel	AISI 303	AISI 316
Springs	Stainless Steel	Stainless Steel	Stainless Steel	Stainless Steel
Seals	NBR	NBR	NBR	FKM
Valve Holder	Stainless Steel	Stainless Steel	Stainless Steel	Stainless Steel
Thread Body	Brass	Steel	AISI 303	AISI 316

**Flow Capacity with Oil with Viscosity of 43cSt at 38°C as per ISO 7241/2-2000**

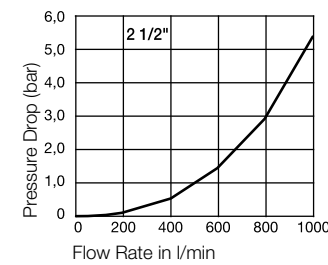
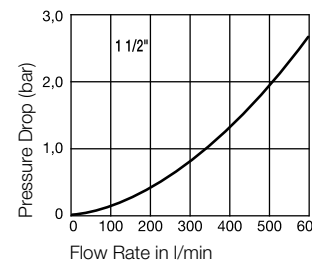
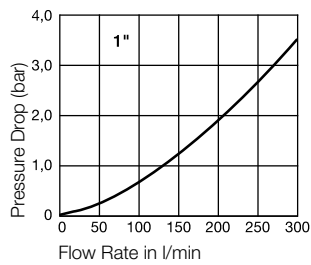
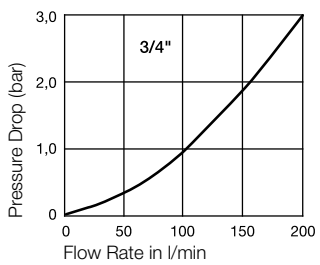
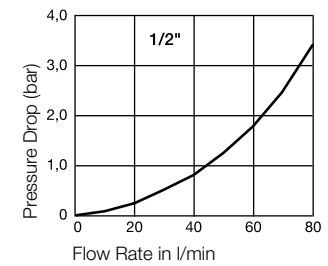
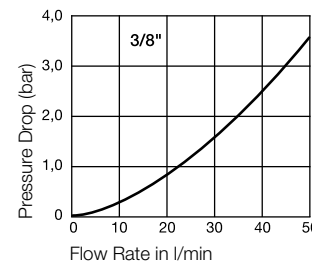
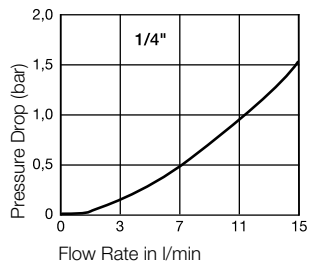
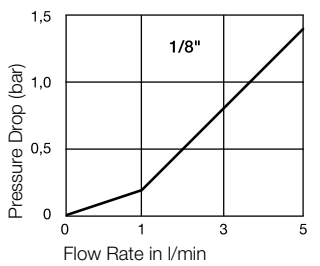

## Couplings

## 60 Series Brass

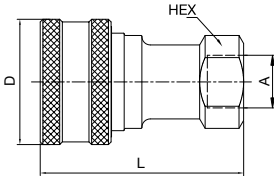
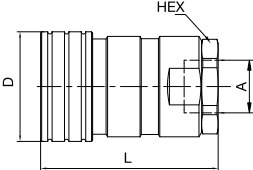
	Body Size	Connection A	Thread	Hex	L mm	L1 mm	D mm	D1 mm	Version	Weight gr.	Part Number
 <p>Female Thread</p>	1/8"	1/8"	BSPP	11/16"	48,3		24,4		Brass	87	BH1-60-BSPP
	1/8"	1/8" - 27	NPTF	11/16"	48,3		24,4		Brass	80	BH1-60
	1/4"	1/4"	BSPP	13/16"	61,2		29		Brass	158	BH2-60-BSPP
	1/4"	1/4" - 18	NPTF	13/16"	57,4		29		Brass	145	BH2-60
	3/8"	3/8"	BSPP	1"	69,9		35,6		Brass	260	BH3-60-BSPP
	3/8"	3/8" - 18	NPTF	7/8"	63,2		35,4		Brass	195	BH3-60
	1/2"	1/2"	BSPP	1 1/8"	77,5		45		Brass	383	BH4-60-BSPP
	1/2"	1/2" - 14	NPTF	1 1/8"	72,9		45		Brass	365	BH4-60
	3/4"	3/4"	BSPP	1 5/16"	93,2		54,4		Brass	642	BH6-60-BSPP
	3/4"	3/4" - 14	NPTF	1 5/16"	90,4		54,4		Brass	630	BH6-60
	1"	1"	BSPP	1 5/8"	106,2		64		Brass	970	BH8-60-BSPP
	1"	1" - 11 1/2	NPTF	1 5/8"	106,2		64		Brass	980	BH8-60
 <p>Female Thread</p>	1 1/2"	1 1/4"	BSPP	2 3/8"	123,4		76,2		Brass	2145	BH12-60L-BSPP
	1 1/2"	1 1/2"	BSPP	2 3/8"	127,3		76,2		Brass	2130	BH12-60N-BSPP
	1 1/2"	1 1/4" - 11 1/2	NPTF	2 3/8"	123,4		76,2		Brass	2080	BH12-60L
	1 1/2"	1 1/2" - 11 1/2	NPTF	2 3/8"	123,4		76,2		Brass	2080	BH12-60N
	2 1/2"	2"	BSPP	3 3/4"	145		101,1		Brass	5500	BH2016-60-BSPP
	2 1/2"	2" - 11 1/2	NPTF	3 3/4"	141,5		101,1		Brass	5015	BH2016-60

## Plugs

## 60 Series Brass

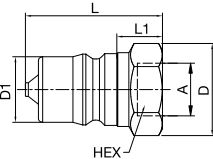
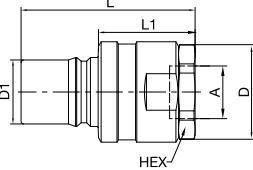
	Body Size	Connection A	Thread	Hex	L mm	L1 mm	D mm	D1 mm	Version	Weight gr.	Part Number
 <p>Female Thread</p>	1/8"	1/8"	BSPP	9/16"	32	10,5	16,4	10,8	Brass	19	BH1-61-BSPP
	1/8"	1/8" - 27	NPTF	9/16"	32	11,2	16,5	10,8	Brass	19	BH1-61
	1/4"	1/4"	BSPP	3/4"	42,9	16,6	21,9	14,2	Brass	45	BH2-61-BSPP
	1/4"	1/4" - 18	NPTF	3/4"	39,1	14	21,9	14,2	Brass	46	BH2-61
	3/8"	3/8"	BSPP	7/8"	49,3	19,7	25,7	19,1	Brass	74	BH3-61-BSPP
	3/8"	3/8" - 18	NPTF	7/8"	42,7	13,1	25,6	19,1	Brass	62	BH3-61
	1/2"	1/2"	BSPP	1 1/8"	54,1	21,1	32,9	23,5	Brass	131	BH4-61-BSPP
	1/2"	1/2" - 14	NPTF	1 1/8"	49,3	17,5	33	23,5	Brass	118	BH4-61
	3/4"	3/4"	BSPP	1 3/8"	64,5	21,9	40,3	31,4	Brass	235	BH6-61-BSPP
	3/4"	3/4" - 14	NPTF	1 3/8"	61,7	20,1	40,3	31,4	Brass	229	BH6-61
	1"	1"	BSPP	1 5/8"	73,8	25,2	47,2	37,7	Brass	368	BH8-61-BSPP
	1"	1" - 11 1/2	NPTF	1 5/8"	73,9	33,4	47,8	37,7	Brass	378	BH8-61
 <p>Female Thread</p>	1 1/2"	1 1/4"	BSPP	2 3/8"	120,9	67,5	74,7	44,5	Brass	1450	BH12-61L-BSPP
	1 1/2"	1 1/2"	BSPP	2 3/8"	124,7	67,5	74,7	44,5	Brass	1450	BH12-61N-BSPP
	1 1/2"	1 1/4" - 11 1/2	NPTF	2 3/8"	120,9	67,3	69,9	44,5	Brass	1340	BH12-61L
	1 1/2"	1 1/2" - 11 1/2	NPTF	2 3/8"	120,9	67,3	69,9	44,5	Brass	1340	BH12-61N
	2 1/2"	2"	BSPP	3 3/4"	142,7	77,3	104,1	63,2	Brass	3855	BH2016-61-BSPP
	2 1/2"	2" - 11 1/2	NPTF	3 3/4"	139,2	73,7	104,1	63,2	Brass	3530	BH2016-61

# Couplings

# 60 Series Steel

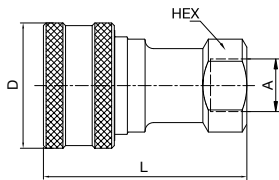

Female Thread

Body Size	Connection A	Thread	Hex	L mm	L1 mm	D mm	D1 mm	Version	Weight gr.	Part Number
1/8"	1/8"	BSPP	11/16"	48,3		24,4		Steel	81	H1-62-BSPP
1/8"	1/8" - 27	NPTF	11/16"	48,3		24,4		Steel	81	H1-62
1/4"	1/4"	BSPP	13/16"	61,2		29,0		Steel	130	H2-62-BSPP
1/4"	1/4" - 18	NPTF	13/16"	57,4		29,0		Steel	138	H2-62
3/8"	3/8"	BSPP	1"	69,9		35,6		Steel	241	H3-62-BSPP
3/8"	3/8" - 18	NPTF	7/8"	63,2		35,4		Steel	184	H3-62
1/2"	1/2"	BSPP	1 1/8"	77,5		45,0		Steel	360	H4-62-BSPP
1/2"	1/2" - 14	NPTF	1 1/8"	72,9		45,0		Steel	341	H4-62
3/4"	3/4"	BSPP	1 5/16"	93,2		54,4		Steel	602	H6-62-BSPP
3/4"	3/4" - 14	NPTF	1 5/16"	90,4		54,4		Steel	592	H6-62
1"	1"	BSPP	1 5/8"	106,2		64,0		Steel	906	H8-62-BSPP
1"	1" - 11 1/2	NPTF	1 5/8"	106,2		64,0		Steel	914	H8-62

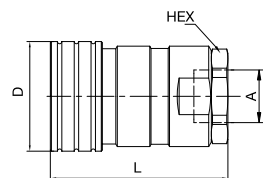

Female Thread

1 1/2"	1 1/4"	BSPP	2 3/8"	123,4		76,2		Steel	2135	H12-62L-BSPP
1 1/2"	1 1/2"	BSPP	2 3/8"	127,3		76,2		Steel	2060	H12-62N-BSPP
1 1/2"	1 1/4" - 11 1/2	NPTF	2 3/8"	123,4		76,2		Steel	2130	H12-62L
1 1/2"	1 1/2" - 11 1/2	NPTF	2 3/8"	123,4		76,2		Steel	2130	H12-62N
2 1/2"	2"	BSPP	3 3/4"	145		104,1		Steel	4800	H2016-62-BSPP
2 1/2"	2" - 11 1/2	NPTF	3 3/4"	141,5		104,1		Steel	4800	H2016-62
2 1/2"	2 1/2" - 8	NPTF	3 3/4"	153,4		104,1		Steel	4950	H2020-62

# Plugs

# 60 Series Steel

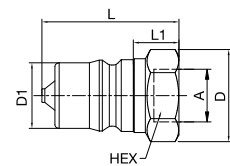

Female Thread

Body Size	Connection A	Thread	Hex	L mm	L1 mm	D mm	D1 mm	Version	Weight gr.	Part Number
1/8"	1/8"	BSPP	9/16"	32	10,5	16,4	10,8	Steel	18	H1-63-BSPP
1/8"	1/8" - 27	NPTF	9/16"	32,0	11,2	16,5	10,8	Steel	18	H1-63
1/4"	1/4"	BSPP	3/4"	42,9	16,6	21,9	14,2	Steel	38	H2-63-BSPP
1/4"	1/4" - 18	NPTF	3/4"	39,1	14,0	21,9	14,2	Steel	36	H2-63
3/8"	3/8"	BSPP	7/8"	49,3	19,7	25,7	19,1	Steel	68	H3-63-BSPP
3/8"	3/8" - 18	NPTF	7/8"	42,7	13,1	25,6	19,1	Steel	56	H3-63
1/2"	1/2"	BSPP	1 1/8"	54,1	21,1	32,9	23,5	Steel	122	H4-63-BSPP
1/2"	1/2" - 14	NPTF	1 1/8"	49,3	17,5	33	23,5	Steel	109	H4-63
3/4"	3/4"	BSPP	1 3/8"	64,5	21,9	40,3	31,4	Steel	217	H6-63-BSPP
3/4"	3/4" - 14	NPTF	1 3/8"	61,7	20,1	40,3	31,4	Steel	210	H6-63
1"	1"	BSPP	1 5/8"	73,8	25,2	47,2	37,7	Steel	340	H8-63-BSPP
1"	1" - 11 1/2	NPTF	1 5/8"	73,9	33,4	47,8	37,7	Steel	351	H8-63

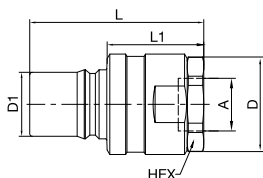

Female Thread

1 1/2"	1 1/4"	BSPP	2 3/8"	120,9	67,5	69,9	44,5	Steel	1410	H12-63L-BSPP
1 1/2"	1 1/2"	BSPP	2 3/8"	124,7	71,1	69,9	44,5	Steel	1280	H12-63N-BSPP
1 1/2"	1 1/4" - 11 1/2	NPTF	2 3/8"	120,9	67,3	69,9	44,5	Steel	1365	H12-63L
1 1/2"	1 1/2" - 11 1/2	NPTF	2 3/8"	120,9	67,3	69,9	44,5	Steel	1405	H12-63N
2 1/2"	2"	BSPP	3 3/4"	142,7	69,4	104,1	63,2	Steel	3580	H2016-63-BSPP
2 1/2"	2" - 11 1/2	NPTF	3 3/4"	139,2	65,9	104,1	63,2	Steel	3580	H2016-63
2 1/2"	2 1/2" - 8	NPTF	3 3/4"	151,1	83,4	104,1	63,2	Steel	3700	H2020-63

## Couplings

## 60 Series Stainless Steel

Body Size	Connection A	Thread	Hex	L mm	L1 mm	D mm	D1 mm	Version	Weight gr.	Part Number
1/8"	1/8"	BSPP	11/16"	48,3		24,4		AISI 303	81	SH1-62-BSPP
1/8"	1/8"	BSPP	14 mm	48,3		24,0		AISI 316	74	SSH1-62Y-BSPP*
1/8"	1/8" - 27	NPTF	11/16"	48,3		24,4		AISI 303	81	SH1-62
1/8"	1/8" - 27	NPTF	11/16"	48,3		24,4		AISI 316	74	SSH1-62Y*
1/4"	1/4"	BSPP	19 mm	61,2		29,0		AISI 303	129	SH2-62-BSPP
1/4"	1/4"	BSPP	13/16"	61,2		29,0		AISI 316	46	SSH2-62Y-BSPP*
1/4"	1/4" - 18	NPTF	13/16"	57,4		29,0		AISI 303	128	SH2-62
1/4"	1/4" - 18	NPTF	13/16"	57,4		29,0		AISI 316	138	SSH2-62Y*
3/8"	3/8"	BSPP	1"	69,9		35,6		AISI 303	245	SH3-62-BSPP
3/8"	3/8"	BSPP	1"	69,9		35,6		AISI 316	187	SSH3-62Y-BSPP*
3/8"	3/8" - 18	NPTF	7/8"	63,2		35,4		AISI 303	186	SH3-62
3/8"	3/8" - 18	NPTF	7/8"	63,2		35,4		AISI 316	180	SSH3-62Y*
1/2"	1/2"	BSPP	1 1/8"	77,5		45,0		AISI 303	360	SH4-62-BSPP
1/2"	1/2"	BSPP	1 1/8"	77,5		45,0		AISI 316	367	SSH4-62Y-BSPP*
1/2"	1/2" - 14	NPTF	1 1/8"	72,9		45,0		AISI 303	341	SH4-62
1/2"	1/2" - 14	NPTF	1 1/8"	72,9		45,0		AISI 316	346	SSH4-62Y*
3/4"	3/4"	BSPP	1 5/16"	93,2		54,4		AISI 303	603	SH6-62-BSPP
3/4"	3/4"	BSPP	1 5/16"	93,2		54,4		AISI 316	610	SSH6-62Y-BSPP*
3/4"	3/4" - 14	NPTF	1 5/16"	90,4		54,4		AISI 303	595	SH6-62
3/4"	3/4" - 14	NPTF	1 5/16"	90,4		54,4		AISI 316	592	SSH6-62Y*
1"	1"	BSPP	1 5/8"	106,2		64,0		AISI 303	908	SH8-62-BSPP
1"	1"	BSPP	41 mm	106,2		64,0		AISI 316	899	SSH8-62Y-BSPP*
1"	1" - 11 1/2	NPTF	1 5/8"	106,2		64,0		AISI 303	924	SH8-62
1"	1" - 11 1/2	NPTF	1 5/8"	106,2		64,0		AISI 316	901	SSH8-62Y*
1 1/2"	1 1/2"	BSPP	2 1/2"	127,3		76,2		AISI 303	2090	SH12-62N-BSPP
1 1/2"	1 1/2" - 11 1/2	NPTF	2 3/8"	123,4		76,2		AISI 303	2090	SH12-62N

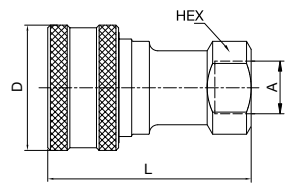

Female Thread

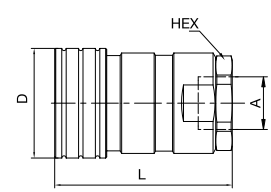

Female Thread

## Plugs

## 60 Series Stainless Steel

Body Size	Connection A	Thread	Hex	L mm	L1 mm	D mm	D1 mm	Version	Weight gr.	Part Number
1/8"	1/8"	BSPP	9/16"	32,0	10,5	16,4	10,8	AISI 303	18	SH1-63-BSPP
1/8"	1/8"	BSPP	17 mm	32,0	10,5	19,6	10,8	AISI 316	22	SSH1-63Y-BSPP*
1/8"	1/8" - 27	NPTF	9/16"	32,0	11,2	16,5	10,8	AISI 303	18	SH1-63
1/8"	1/8" - 27	NPTF	9/16"	32,0	11,2	16,5	10,8	AISI 316	18	SSH1-63Y*
1/4"	1/4"	BSPP	19 mm	39,1	16,6	21,9	14,2	AISI 303	36	SH2-63-BSPP
1/4"	1/4"	BSPP	3/4"	42,9	16,6	21,9	14,2	AISI 316	42	SSH2-63Y-BSPP*
1/4"	1/4" - 18	NPTF	3/4"	39,1	14,0	21,9	14,2	AISI 303	37	SH2-63
1/4"	1/4" - 18	NPTF	3/4"	39,1	14,0	21,9	14,2	AISI 316	37	SSH2-63Y*

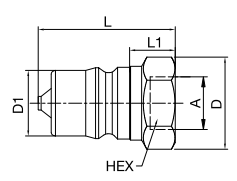

Female Thread

\*Suffix Y designates FKM seal.



# Plugs

# 60 Series Stainless Steel

Body Size	Connection A	Thread	Hex	L mm	L1 mm	D mm	D1 mm	Version	Weight gr.	Part Number
3/8"	3/8"	BSPP	7/8"	49,3	19,7	25,7	19,1	AISI 303	69	SH3-63-BSPP
3/8"	3/8"	BSPP	7/8"	49,3	19,7	25,7	19,1	AISI 316	60	SSH3-63Y-BSPP*
3/8"	3/8" - 18	NPTF	7/8"	42,7	13,1	25,6	19,1	AISI 303	58	SH3-63
3/8"	3/8" - 18	NPTF	7/8"	42,7	13,1	25,6	19,1	AISI 316	55	SSH3-63Y*
1/2"	1/2"	BSPP	1 1/8"	54,1	21,1	32,9	23,5	AISI 303	122	SH4-63-BSPP
1/2"	1/2"	BSPP	1 1/8"	54,1	21,1	32,9	23,5	AISI 316	123	SSH4-63Y-BSPP*
1/2"	1/2" - 14	NPTF	1 1/8"	49,3	17,5	33,0	23,5	AISI 303	109	SH4-63
1/2"	1/2" - 14	NPTF	1 1/8"	49,3	17,5	33,0	23,5	AISI 316	109	SSH4-63Y*
3/4"	3/4"	BSPP	1 3/8"	64,5	21,9	40,3	31,4	AISI 303	217	SH6-63-BSPP
3/4"	3/4"	BSPP	1 3/8"	64,5	21,9	40,3	31,4	AISI 316	218	SSH6-63-BSPP*
3/4"	3/4" - 14	NPTF	1 3/8"	61,7	20,1	40,3	31,4	AISI 303	212	SH6-63
3/4"	3/4" - 14	NPTF	1 3/8"	61,7	20,1	40,3	31,4	AISI 316	210	SSH6-63Y*
1"	1"	BSPP	1 5/8"	73,8	25,2	47,2	37,7	AISI 303	345	SH8-63-BSPP
1"	1"	BSPP	1 5/8"	73,8	25,2	47,2	37,7	AISI 316	340	SH8-63Y-BSPP*
1"	1" - 11 1/2	NPTF	1 5/8"	73,9	33,4	47,8	37,7	AISI 303	356	SH8-63
1"	1" - 11 1/2	NPTF	1 5/8"	73,9	33,4	47,8	37,7	AISI 316	345	SSH8-63Y*
1 1/2"	1 1/2"	BSPP	2 1/2"	124,7	67,5	69,9	44,5	AISI 303	1315	SH12-63N-BSPP
1 1/2"	1 1/2" - 11 1/2	NPTF	2 3/8"	120,9	67,3	69,9	44,5	AISI 303	1315	SH12-63N

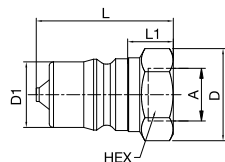

Female Thread

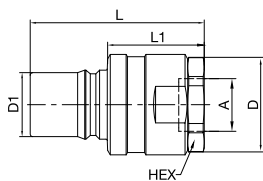

Female Thread

\* Suffix Y designates FKM seal.

# Dust Protection

# 60 Series

Body Size	Version	Material	Part Number
1/8"	for coupling	Aluminium	H1-65
1/8"	for coupling	Rubber	H1-65M
1/8"	for plug	Aluminium	H1-66
1/8"	for plug	Rubber	H1-66M
1/4"	for coupling	Aluminium	H2-65
1/4"	for coupling	Rubber	H2-65M
1/4"	for plug	Aluminium	H2-66
1/4"	for plug	Rubber	H2-66M
3/8"	for coupling	Aluminium	H3-65
3/8"	for coupling	Rubber	H3-65M
3/8"	for plug	Aluminium	H3-66
3/8"	for plug	Rubber	H3-66M

Stainless steel AISI 316 dust protections are available on request.

## Dust Protection

## 60 Series

Body Size	Version	Material	Part Number
1/2"	for coupling	Aluminium	H4-65
1/2"	for coupling	Rubber	H4-65M
1/2"	for plug	Aluminium	H4-66
1/2"	for plug	Rubber	H4-66M
3/4"	for coupling	Aluminium	H6-65
3/4"	for coupling	Rubber	H6-65M
3/4"	for plug	Aluminium	H6-66
3/4"	for plug	Rubber	H6-66M
1"	for coupling	Aluminium	H8-65
1"	for coupling	Rubber	H8-65M
1"	for plug	Aluminium	H8-66
1"	for plug	Rubber	H8-66M
1 1/2"	for coupling	Aluminium	H12-65
1 1/2"	for plug	Aluminium	H12-66

Stainless steel AISI 316 dust protections are available upon request.

## Seal-Kit

## 60 Series

Body Size	Version	Material	Part Number
1/8"	Body Seal	NBR	020013N0674
1/8"	Body Seal	FKM	020013V0747
1/8"	Back-up Ring <sup>2</sup>	PTFE	H67A-28
1/4"	Body Seal	NBR	020015N0674
1/4"	Body Seal	FKM	020015V0747
1/4"	Back-up Ring <sup>2</sup>	PTFE	H67C-28
3/8"	Body Seal	NBR	020116N0674
3/8"	Body Seal	FKM	020116V0747
3/8"	Back-up Ring <sup>2</sup>	PTFE	4118007
1/2"	Body Seal	NBR	020213N0674
1/2"	Body Seal	FKM	020213V0747
1/2"	Back-up Ring <sup>2</sup>	PTFE	4128002
3/4"	Body Seal	NBR	020218N0674
3/4"	Body Seal	FKM	020218V0747
3/4"	Back-up Ring <sup>2</sup>	PTFE	4148001
1"	Body Seal	NBR	020222N0674
1"	Body Seal	FKM	020222V0747
1"	Back-up Ring <sup>2</sup>	PTFE	4158001
1 1/2"	Body Seal	NBR	020224N0674 <sup>1</sup>
2 1/2"	Body Seal	NBR	020333N0674

<sup>1</sup> Two body seals are necessary

<sup>2</sup> Brass 60 series couplers use two O-rings but do not use a back-up ring.



Body Size

1/4" up to 1"

ISO B-Series

# Tema IB-Series

Medium Pressure



### Technical Description

The Tema IB series plug profiles conform to ISO Standard 7241-1 series B and are compatible with other series complying with the same standard. To optimize performance and corrosion resistance the female is made from brass and the male hardend steel.

### Advantages

Option with pressure eliminator function allows for effortless connection with static and residual pressure, up to operating pressure. It is available in the IB series for plugs and couplings. Option with heavy duty sleeve gives longer life time in very tough applications.

### Working Temperature

-30°C up to +100°C (NBR)  
-25°C up to +200°C (FKM)  
depending on the medium. Special seals are available on request (see page 6 ff).

### Available Valves

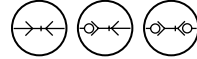

### Working Pressure

See charts.

### Applications Area



Material Coupling	Standard / Pressure Eliminator
Coupling Body Size 1/4" to 1/2"	Brass, nickel and chrome plated
Coupling Body Size 3/4" to 1"	Steel zinc plated, passivated, sealed
Sleeve size 1/4"	Brass, nickel & Chrome plated
Sleeve size 3/8" to 1"	Steel zinc plated, passivated, sealed
Valve	Brass
Springs	AISI 301
Locking Balls	AISI 420 C
Seals	NBR/FKM
Valve Holder (up to 100°C)	Zinc casting
Valve Holder (over 100°C)	Brass
Material Plug	Standard / Pressure Eliminator
Plug Body	Steel hardened, zinc plated, passivated, sealed
Valve	Brass
Springs	AISI 301
Seals	NBR/FKM
Valve Holder (up to 100°C)	Zinc Casting, Size 3/8" & 1/2", Brass Size 1/4", 3/4", 1"
Valve Holder (over 100°C)	Brass

### Flow Capacity with Oil with Viscosity of 32cSt at 40°C as per ISO 7241/2-2000

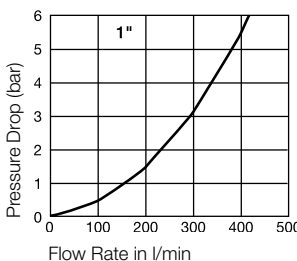
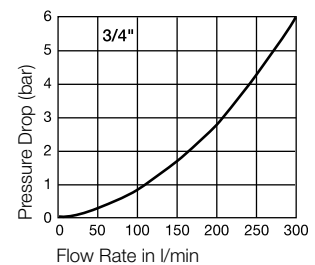
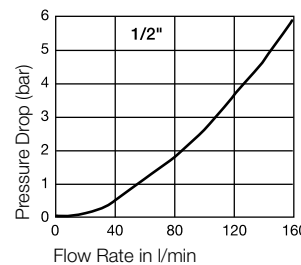
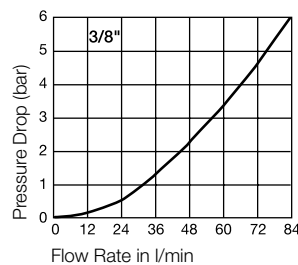
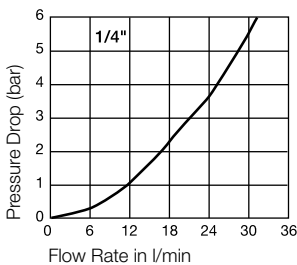

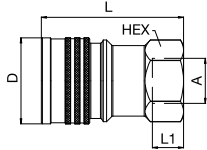

Female Thread

Body Size	Connection A	Hex mm	L mm	L1 mm	D mm	D1 mm	Valve	Working Pressure connected in bar	Version	Seal	Part Number
1/4"	G 1/4	24	57	12	28		with	400	Standard	NBR	IB2510
1/4"	G 1/4	24	57	12	28		with	400	Standard	FKM	IB2510 V
1/4"	G 1/4	24	57	12	28		without	400	Standard	NBR	IB2510 UV
1/4"	G 1/4	24	57	12	28		without	400	Standard	FKM	IB2510 VUV
3/8"	G 3/8	30	63	12	34		with	320	Standard	NBR	IB3810
3/8"	G 3/8	30	63	12	34		with	320	Standard	FKM	IB3810 V
3/8"	G 3/8	30	63	12	34		without	320	Standard	NBR	IB3810 UV
3/8"	G 3/8	30	63	12	34		without	320	Standard	FKM	IB3810 VUV
1/2"	G 1/2	33	66	14	39		with	300	Standard	NBR	IB5010
1/2"	G 1/2	33	66	14	39		with	300	Standard	FKM	IB5010 V
1/2"	G 1/2	33	66	14	39		without	300	Standard	NBR	IB5010 UV
1/2"	G 1/2	33	66	14	39		without	300	Standard	FKM	IB5010 VUV
3/4"	G 3/4	46	81	16	52		with	300	Standard	NBR	IB7510
3/4"	G 3/4	46	81	16	52		with	300	Standard	FKM	IB7510 V
3/4"	G 3/4	46	81	16	52		without	300	Standard	NBR	IB7510 UV
3/4"	G 3/4	46	81	16	52		without	300	Standard	FKM	IB7510 VUV
1"	G 1	50	94	18	62		with	250	Standard	NBR	IB10010
1"	G 1	50	94	18	62		with	250	Standard	FKM	IB10010 V
1"	G 1	50	94	18	62		without	250	Standard	NBR	IB10010 UV
1"	G 1	50	94	18	62		without	250	Standard	FKM	IB10010 VUV

## Couplings with Heavy Duty Sleeve

## IB-Series

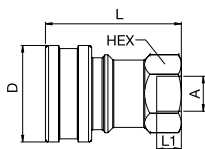

Female Thread

Body Size	Connection A	Hex mm	L mm	L1 mm	D mm	D1 mm	Valve	Working Pressure connected in bar	Version	Seal	Part Number
1/2"	G 1/2	33	66	14	47		with	300	Standard	NBR	IB5010 H
1/2"	G 1/2	33	66	14	47		without	300	Standard	NBR	IB5010 HUV
3/4"	G 3/4	46	81	16	56		with	300	Standard	NBR	IB7510 H
3/4"	G 3/4	46	81	16	56		without	300	Standard	NBR	IB7510 HUV
1"	G 1	50	94	18	66		with	250	Standard	NBR	IB10010 H
1"	G 1	50	94	18	66		with	250	Standard	FKM	IB10010 HV
1"	G 1	50	94	18	66		without	250	Standard	NBR	IB10010 HUV
1"	G 1	50	94	18	66		without	250	Standard	FKM	IB10010 HVUV

# Plugs

# IB-Series

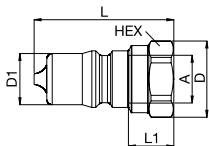

Female Thread

Body Size	Connection A	Hex mm	L mm	L1 mm	D mm	D1 mm	Valve	Working Pressure connected in bar	Version	Seal	Part Number
1/4"	G 1/4	19	38	12	21	14,1	with	400	Standard	NBR	IB2520
1/4"	G 1/4	19	38	12	21	14,1	with	400	Standard	FKM	IB2520 V
1/4"	G 1/4	19	38	12	21	14,1	without	400	Standard	-	IB2520 UV
3/8"	G 3/8	22	42	12	24	19	with	320	Standard	NBR	IB3820
3/8"	G 3/8	22	42	12	24	19	with	320	Standard	FKM	IB3820 V
3/8"	G 3/8	22	38	12	24	19	without	320	Standard	-	IB3820 UV
1/2"	G 1/2	28	48	14	31	23,6	with	300	Standard	NBR	IB5020
1/2"	G 1/2	28	48	14	31	23,6	with	300	Standard	FKM	IB5020 V
1/2"	G 1/2	28	42	14	31	23,6	without	300	Standard	-	IB5020 UV
3/4"	G 3/4	36	59	24	39	31,4	with	300	Standard	NBR	IB7520
3/4"	G 3/4	36	59	24	39	31,4	with	300	Standard	FKM	IB7520 V
3/4"	G 3/4	36	53	24	39	31,4	without	300	Standard	-	IB7520 UV
1"	G 1	42	70	18	46	37,8	with	300	Standard	NBR	IB10020
1"	G 1	42	70	18	46	37,8	with	300	Standard	FKM	IB10020 V
1"	G 1	42	70	18	46	37,8	without	300	Standard	-	IB10020 UV

# Couplings

# IB-Series Pressure Eliminator

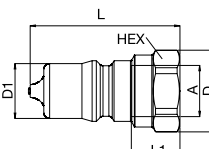

Female Thread

Body Size	Connection A	Hex mm	L mm	L1 mm	D mm	D1 mm	Valve	Working Pressure connected in bar	Version	Seal	Part Number
1/4"	G 1/4	24	57	12	28		with	400	Press. Elim.	NBR	IB2511
1/4"	G 1/4	24	57	12	28		with	400	Press. Elim.	FKM	IB2511 V
3/8"	G 3/8	30	63	12	34		with	320	Press. Elim.	NBR	IB3811
3/8"	G 3/8	30	63	12	34		with	320	Press. Elim.	FKM	IB3811 V
1/2"	G 1/2	33	66	14	39		with	300	Press. Elim.	NBR	IB5011
1/2"	G 1/2	33	66	14	39		with	300	Press. Elim.	FKM	IB5011 V
3/4"	G 3/4	46	81	16	52		with	300	Press. Elim.	NBR	IB7511
3/4"	G 3/4	46	81	16	52		with	300	Press. Elim.	FKM	IB7511 V
1"	G 1	50	94	18	62		with	300	Press. Elim.	NBR	IB10011

# Couplings with Heavy Duty Sleeve

# IB-Series Pressure Eliminator

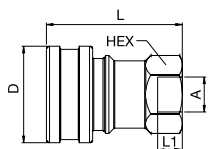

Female Thread

Body Size	Connection A	Hex mm	L mm	L1 mm	D mm	D1 mm	Valve	Working Pressure connected in bar	Version	Seal	Part Number
1/2"	G 1/2	33	66	14	47		with	300	Press. Elim.	NBR	IB5011 H
3/4"	G 3/4	46	81	16	56		with	300	Press. Elim.	NBR	IB7511 H
1"	G 1	50	94	18	66		with	300	Press. Elim.	NBR	IB10011 H

## Plugs

## IB-Series Pressure Eliminator

Body Size	Connection A	Hex mm	L mm	L1 mm	D mm	D1 mm	Valve	Working Pressure connected in bar	Version	Seal	Part Number
1/4"	G 1/4	19	38	12	21	14,1	with	400	Press. Elim.	NBR	IB2521
1/4"	G 1/4	19	38	12	21	14,1	with	400	Press. Elim.	FKM	IB2521 V
3/8"	G 3/8	22	42	12	24	19	with	320	Press. Elim.	NBR	IB3821
3/8"	G 3/8	22	42	12	24	19	with	320	Press. Elim.	FKM	IB3821 V
1/2"	G 1/2	28	48	14	31	23,6	with	300	Press. Elim.	NBR	IB5021
1/2"	G 1/2	28	48	14	31	23,6	with	300	Press. Elim.	FKM	IB5021 V
3/4"	G 3/4	36	59	24	39	31,4	with	300	Press. Elim.	NBR	IB7521
3/4"	G 3/4	36	59	24	39	31,4	with	300	Press. Elim.	FKM	IB7521 V
1"	G 1	42	70	18	46	37,8	with	300	Press. Elim.	NBR	IB10021

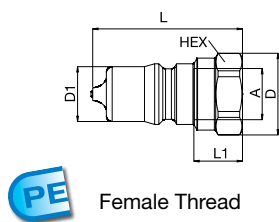

## Seal-Kit

## IB-Series

Body Size	Version	Material	Part Number
1/4"	for coupling	NBR	IB2500-PSN
1/4"	for coupling	FKM	IB2500-PSV
3/8"	for coupling	NBR	IB3800-PSN
3/8"	for coupling	FKM	IB3800-PSV
1/2"	for coupling	NBR	IB5000-PSN
1/2"	for coupling	FKM	IB5000-PSV
3/4"	for coupling	NBR	IB7500-PSN
3/4"	for coupling	FKM	IB7500-PSV
1"	for coupling	NBR	IB10000-PSN
1"	for coupling	FKM	IB10000-PSV

Further sealing materials on request.

## Dust Protection

## IB-Series

Body Size	Version	L mm	D mm	Material	Color	Part Number
1/4"	for coupling	145	19	PVC	Blue	IB2516
1/4"	for coupling	145	19	PVC	Yellow	IB2516 Y
3/8"	for coupling	145	19	PVC	Blue	IB3816
1/2"	for coupling	170	60	PVC	Blue	IB5016
3/4"	for coupling	195	33	PVC	Blue	IB7516
1"	for coupling	230	42	PVC	Blue	IB10016
1/4"	for plug	145	19	PVC	Blue	IB2526
1/4"	for plug	145	19	PVC	Yellow	IB2526 Y
3/8"	for plug	145	19	PVC	Blue	IB3826
1/2"	for plug	170	52	PVC	Blue	IB5026
3/4"	for plug	195	33	PVC	Blue	IB7526
1"	for plug	230	42	PVC	Blue	IB10026

Further colors on request.

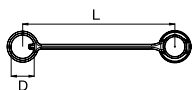



Body Size

1/8" up to 1"

ISO Standard 16028

# FEM- / IF-Series

Medium Pressure



### Technical Description

The FEM, FEC and IF series plug profile are produced according to ISO Standard 16028 and are compatible with other series complying with the same standard. These couplings offer a spill free disconnection – minimal oil loss during uncoupling. Thanks to the valve design, the coupling has a minimum pressure drop, and thus achieves maximum cost-effectiveness. Exists in standard version (steel) and stainless steel.

### Advantages

Can be operated with use of one hand.  
Safety locking feature as standard to prevent unintentional uncoupling.  
FEC with the pressure eliminator enable effortless connection under static pressure (up to rated working pressure).  
FEMP and FECP with push-pull features is suitable for multi-plates or when coupling is fixed on an application.

### Working Pressure

See charts.

### Working Temperature

-30°C up to +100°C (NBR)  
-25°C up to +200°C (FKM)  
depending on the medium.  
Special seals are available on request (see page 6 ff).

### Available Valves



### Applications Area



Material Coupling	FEM-Series: Standard / Steel	FEC-Series: Push-Pull/Press. Elimin.	IF-Series Stainl. Steel
Coupling Body	Steel, zinc plated, passivated, sealed	Steel, nitrocarburizing	AISI 316
Sleeve	Steel, zinc plated, passivated, sealed	Steel, zinc plated, passivated, sealed	AISI 316
Valve	Steel, zinc plated, passivated, sealed	Steel, zinc plated, passivated, sealed	AISI 316
2nd Valve		Brass	
Springs	AISI 301	AISI 301	AISI 301
Locking Balls	AISI 420 C	AISI 420 C	AISI 420 C
Seals	NBR	NBR	FKM
Valve Holder	Steel, zinc plated, passivated	Steel, zinc plated, passivated, sealed	AISI 316
2nd Valve Holder (up to 100°C)		Zinc Casting (NBR)	
2nd Valve Holder (over 100°C)		Brass (EPDM/FKM)	AISI 316
Thread Body	Steel, zinc plated, passivated, sealed	Steel, zinc plated, passivated, sealed	
Material Plug	FEM-Series: Standard / Steel	FEC-Series: Push-Pull/Press. Elimin.	IF-Series Stainl. Steel
Plug Connection Face	Steel hardened, zinc plated, passiv., sealed	Steel hardened, zinc plated, passiv., sealed	AISI 316
Valve	Brass	Steel hardened, zinc plated, passiv., sealed	AISI 316
2nd Valve		Brass	
Springs	AISI 301	AISI 301	AISI 301
Seals	NBR/FKM	PUR	FKM
Valve Holder	Zinc Casting	Brass	AISI 316
2nd Valve Holder (up to 100°C)		Zinc Casting (NBR)	
2nd Valve Holder (over 100°C)		Brass (EPDM/FKM)	AISI 316

### Flow Capacity with Oil with Viscosity of 32cSt at 40°C as per ISO 7241/2-2000

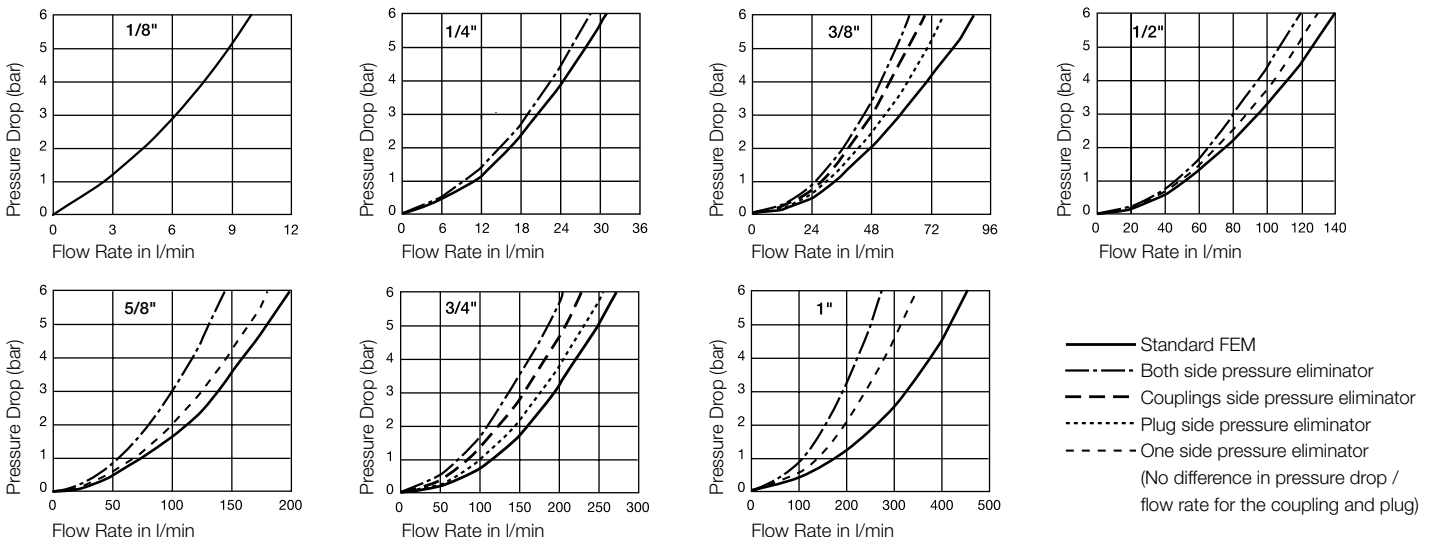



## Couplings

## FEM-Series Standard

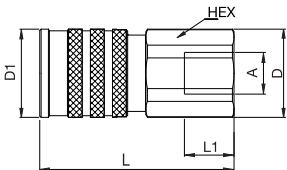

Body Size	Connection A	Hex mm	L mm	L1 mm	D mm	D1 mm	Working Pressure connected in bar	Version	Seal	Part Number*
1/8"	G 1/8	19	40	8	20,5	20	450	Standard	NBR	FEM-121-2FB
1/4"	G 1/4	27	64	12	29,5	29	315	Standard	NBR	FEM-251-4FB
3/8"	G 3/8	30	71	12	32	32	250	Standard	NBR	FEM-371-6FB
3/8"	G 1/2	30	73	14	32	32	250	Standard	NBR	FEM-371-8FB
3/8"	G 1/2	30	73	14	32	32	250	Standard	FKM	FEM-371-8FB-E4
3/8"	7/8"-14 UNF	30	76	14	32	32	250	Standard	NBR	FEM-371-10FO
3/8"	M 18 x 1,5	30	90	11	32	32	250	Standard	NBR	FEM-371-18MCL
1/2"	G 1/2	36	76	14	40	39	250	Standard	NBR	FEM-501-8FB
1/2"	G 3/4	36	80	16	40	39	250	Standard	NBR	FEM-501-12FB
1/2"	1 1/16"-12 UNF	36	84	19	40	39	250	Standard	NBR	FEM-501-12FO
1/2"	M 18 x 1,5	36	94	11	40	39	250	Standard	NBR	FEM-501-18MCL
5/8"	G 3/4	40	82	16	43	42	250	Standard	NBR	FEM-621-12FB
3/4"	G 1	46	102	18	50	46	250	Standard	NBR	FEM-751-16FB
1"	G 1 1/4	55	106	19	60	55	200	Standard	NBR	FEM-1001-20FB

Female Thread

## Plugs

## FEM-Series Standard

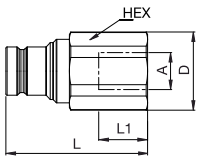

Body Size	Connection A	Hex mm	L mm	L1 mm	D mm	D1 mm	Working Pressure connected in bar	Version	Seal	Part Number*
1/8"	G 1/8	17	35	8	18,6		450	Standard	NBR	FEM-122-2FB
1/4"	G 1/4	22	49	12	24,5		315	Standard	NBR	FEM-252-4FB
3/8"	G 3/8	30	58	12	32		250	Standard	NBR	FEM-372-6FB
3/8"	G 1/2	30	60	12	32		250	Standard	NBR	FEM-372-8FB
3/8"	G 1/2	30	60	12	32		250	Standard	FKM	FEM-372-8FB-E4
3/8"	7/8"-14 UNF	30	63	12	32		250	Standard	NBR	FEM-372-10FO
3/8"	M 18 x 1,5	30	90	11	32		250	Standard	NBR	FEM-372-18MCL
3/8"	M 22 x 1,5	30	91	12	32		250	Standard	NBR	FEM-372-22MCL
1/2"	G 1/2	36	66	14	40		250	Standard	NBR	FEM-502-8FB
1/2"	G 3/4	36	70	16	40		250	Standard	NBR	FEM-502-12FB
1/2"	1 1/16"-12 UNF	36	74	19	40		250	Standard	NBR	FEM-502-12FO
1/2"	M 18 x 1,5	36	80	11	40		250	Standard	NBR	FEM-502-18MCL
5/8"	G 3/4	36	71	16	40		250	Standard	NBR	FEM-622-12FB
3/4"	G 1	46	83	18	50		250	Standard	NBR	FEM-752-16FB
1"	G 1 1/4	55	90	19	60		200	Standard	NBR	FEM-1002-20FB

Female Thread

\* For the old part number please have a look on the Cross-Reference-List on page 43.

## Couplings

## IF-Series Pressure Eliminator

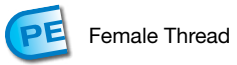
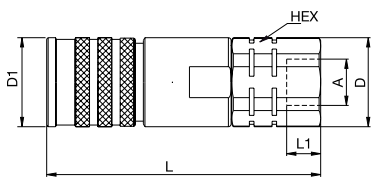

Body Size	Connection A	Hex mm	L mm	L1 mm	L2 mm	D mm	D1 mm	Working Pressure connected in bar	Version	Seal	Part Number*
1/4"	G 1/4	27	91	12		29,5	29	315	Press. Elimin.	NBR	FEC-251-4FB
1/4"	G 3/8	27	91	12		29,5	29	315	Press. Elimin.	NBR	FEC-251-6FB
3/8"	G 3/8	30	99	12		32	32	250	Press. Elimin.	NBR	FEC-371-6FB
3/8"	G 1/2	30	101	14		32	32	250	Press. Elimin.	NBR	FEC-371-8FB
1/2"	G 1/2	40	112	14		43	39	250	Press. Elimin.	NBR	FEC-501-8FB
1/2"	G 3/4	40	115	16		43	39	250	Press. Elimin.	NBR	FEC-501-12FB
5/8"	G 3/4	40	117	16		43	42	250	Press. Elimin.	NBR	FEC-621-12FB
3/4"	G 3/4	50	130	16		54	46	250	Press. Elimin.	NBR	FEC-751-12FB
3/4"	G 1	50	136	16		54	46	250	Press. Elimin.	NBR	FEC-751-16FB
1"	G 1	55	143	18		60	55	250	Press. Elimin.	NBR	FEC-1001-16FB
1"	G 1 1/4	55	146	20		60	55	250	Press. Elimin.	NBR	FEC-1001-20FB

## Plugs

## IF-Series Pressure Eliminator

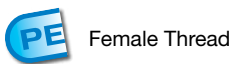
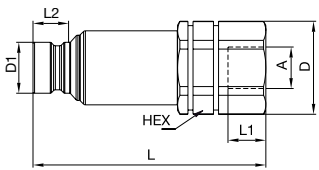

Body Size	Connection A	Hex mm	L mm	L1 mm	L2 mm	D mm	D1 mm	Working Pressure connected in bar	Version	Seal	Part Number*
1/4"	G 1/4	27	74	12	11,3	29,5	16,1	315	Press. Elimin.	NBR	FEC-252-4FB
1/4"	G 3/8	27	74	12	11,3	29,5	16,1	315	Press. Elimin.	NBR	FEC-252-6FB
3/8"	G 3/8	30	87	12	16,1	32	19,7	250	Press. Elimin.	NBR	FEC-372-6FB
3/8"	G 1/2	30	89	14	16,1	32	19,7	250	Press. Elimin.	NBR	FEC-372-8FB
1/2"	G 1/2	40	98	14	17	43	24,5	250	Press. Elimin.	NBR	FEC-502-8FB
1/2"	G 3/4	40	101	16	17	43	24,5	250	Press. Elimin.	NBR	FEC-502-12FB
5/8"	G 3/4	40	101	16	17,7	43	27	250	Press. Elimin.	NBR	FEC-622-12FB
3/4"	G 3/4	50	114	16	22	54	30	250	Press. Elimin.	NBR	FEC-752-12FB
3/4"	G 1	50	120	16	22	54	30	250	Press. Elimin.	NBR	FEC-752-16FB
1"	G 1	55	126	18	23,3	60	36	200	Press. Elimin.	NBR	FEC-1002-16FB
1"	G 1 1/4	55	130	20	23,3	60	36	200	Press. Elimin.	NBR	FEC-1002-20FB

\* For the old part number please have a look on the Cross-Reference-List on page 43.

## Couplings

## IF-Series for Multiplate

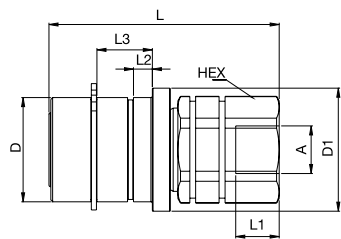

Female Thread  
Provided with Circlip acc. DIN 471

Body Size	Connect. A	Hex mm	L mm	L1 mm	L2 mm	L3 mm	D mm	D1 mm	D2 mm	Work. Press. con. in bar	Version	Seal	Part Number*
1/4"	G 1/4	27	64	12	5,2	15,3	28,8	34		315	for Multiplate	NBR	FEMP-251-4FB
1/4"	G 3/8	27	64	12	5,2	15,3	28,8	34		315	for Multiplate	NBR	FEMP-251-6FB
3/8"	G 3/8	30	71	12	5,2	15,3	31,8	38		250	for Multiplate	NBR	FEMP-371-6FB
3/8"	G 1/2	30	73	14	5,2	15,3	31,8	38		250	for Multiplate	NBR	FEMP-371-8FB
1/2"	G 1/2	36	76	14	5,2	15,3	39,8	46		250	for Multiplate	NBR	FEMP-501-8FB
1/2"	G 3/4	36	80	16	5,2	15,3	39,8	46		250	for Multiplate	NBR	FEMP-501-12FB
5/8"	G 3/4	40	82	16	5,2	15,3	41,8	48		250	for Multiplate	NBR	FEMP-621-12FB
3/4"	G 3/4	46	95	16	5,2	15,3	46,8	53		250	for Multiplate	NBR	FEMP-751-12FB
3/4"	G 1	46	101	18	5,2	15,3	46,8	53		250	for Multiplate	NBR	FEMP-751-16FB
1"	G 1	55	105	18	5,2	15,3	59,8	65		250	for Multiplate	NBR	FEMP-1001-16FB
1"	G 1 1/4	55	109	20	5,2	15,3	59,8	65		250	for Multiplate	NBR	FEMP-1001-20FB

## Plugs

## IF-Series for Multiplate

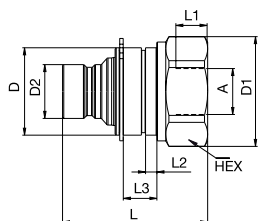

Female Thread  
Provided with Circlip acc. DIN 471

Body Size	Connect. A	Hex mm	L mm	L1 mm	L2 mm	L3 mm	D mm	D1 mm	D2 mm	Work. Press. con. in bar	Version	Seal	Part Number*
1/4"	G 1/4	32	49	12	5,2	15,3	28,8	32	16,1	315	for Multiplate	PUR	FEMP-252-4FB
3/8"	G 3/8	30	58	12	5,2	15,3	31,8	36	19,8	250	for Multiplate	PUR	FEMP-372-6FB
1/2"	G 1/2	45	66	14	5,2	15,3	39,8	45	24,5	250	for Multiplate	PUR	FEMP-502-8FB
5/8"	G 3/4	46	71	16	5,2	15,3	39,8	46	27	250	for Multiplate	PUR	FEMP-622-12FB
3/4"	G 3/4	50	83	16	5,2	15,3	46,8	50	30	250	for Multiplate	PUR	FEMP-752-12FB
1"	G 1	65	89	18	5,2	15,3	59,8	65	36	200	for Multiplate	PUR	FEMP-1002-16FB

## Plugs

## IF-Series Pressure Eliminator for Multiplate

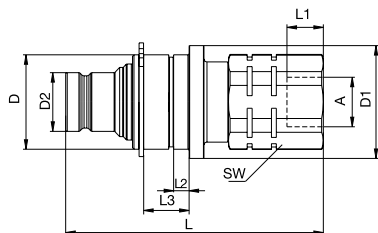

Female Thread  
Provided with Circlip acc. DIN 471



Body Size	Connect. A	Hex mm	L mm	L1 mm	L2 mm	L3 mm	D mm	D1 mm	D2 mm	Work. Press. con. in bar	Version	Seal	Part Number*
1/4"	G 1/4	27	74	12	5,2	15,3	28,8	34	16,1	315	Press. El. f. Multiplate	PUR	FECF-252-4FB
1/4"	G 3/8	27	74	12	5,2	15,3	28,8	34	16,1	315	Press. El. f. Multiplate	PUR	FECF-252-6FB
3/8"	G 3/8	30	87	12	5,2	15,3	31,8	38	19,8	250	Press. El. f. Multiplate	PUR	FECF-372-6FB
3/8"	G 1/2	30	89	14	5,2	15,3	31,8	38	19,8	250	Press. El. f. Multiplate	PUR	FECF-372-8FB
1/2"	G 1/2	40	98	14	5,2	15,3	39,8	46	24,5	250	Press. El. f. Multiplate	PUR	FECF-502-8FB
1/2"	G 3/4	40	101	16	5,2	15,3	39,8	46	24,5	250	Press. El. f. Multiplate	PUR	FECF-502-12FB
5/8"	G 3/4	40	101	16	5,2	15,3	41,8	46	27	250	Press. El. f. Multiplate	PUR	FECF-622-12FB
3/4"	G 3/4	50	114	16	5,2	15,3	46,8	53	30	250	Press. El. f. Multiplate	PUR	FECF-752-12FB
3/4"	G 1	50	120	16	5,2	15,3	46,8	53	30	250	Press. El. f. Multiplate	PUR	FECF-752-16FB
1"	G 1	55	126	18	5,2	15,3	59,8	65	36	200	Press. El. f. Multiplate	PUR	FECF-1002-16FB
1"	G 1 1/4	55	130	20	5,2	15,3	59,8	65	36	200	Press. El. f. Multiplate	PUR	FECF-1002-20FB

\* For the old part number please have a look on the Cross-Reference-List on page 43.

## Couplings

## IF-Series Stainless Steel

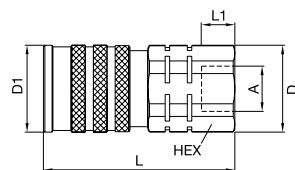

Female Thread

Body Size	Connection A	Hex mm	L mm	L1 mm	L2 mm	D mm	D1 mm	Working Pressure connected in bar	Version	Seal	Part Number
1/4"	G 1/4	27	64	12		29,5	29	315	Stainl. Steel	FKM	IF2510 RV
3/8"	G 3/8	30	71	12		32	32	250	Stainl. Steel	FKM	IF3810 RV
3/8"	G 1/2	30	73	14		32	32	250	Stainl. Steel	FKM	IF3810-50 RV
1/2"	G 1/2	36	76	14		40	39	250	Stainl. Steel	FKM	IF5010 RV
1/2"	G 3/4	36	80	16		40	39	250	Stainl. Steel	FKM	IF5010-75 RV
5/8"	G 3/4	40	82	16		43	42	250	Stainl. Steel	FKM	IF6310 RV
3/4"	G 3/4	46	96	16		50	46	250	Stainl. Steel	FKM	IF7510 RV
3/4"	G 1	46	102	18		50	46	250	Stainl. Steel	FKM	IF7510-100 RV
1"	G 1	55	109	20		60	55	200	Stainl. Steel	FKM	IF10010 RV
1"	G 1 1/4	55	105	18		60	55	200	Stainl. Steel	FKM	IF10010-125 RV

## Plugs

## IF-Series Stainless Steel

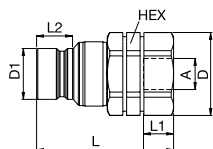

Female Thread

Body Size	Connection A	Hex mm	L mm	L1 mm	L2 mm	D mm	D1 mm	Working Pressure connected in bar	Version	Seal	Part Number
1/4"	G 1/4	22	49	12	11,3	24,5	16,1	315	Stainl. Steel	FKM	IF2520 RV
3/8"	G 3/8	30	58	12	16,1	32	19,7	250	Stainl. Steel	FKM	IF3820 RV
3/8"	G 1/2	30	60	12	16,1	32	19,7	250	Stainl. Steel	FKM	IF3820-50 RV
1/2"	G 1/2	36	66	14	17	40	24,5	250	Stainl. Steel	FKM	IF5020 RV
1/2"	G 3/4	36	70	16	17	40	24,5	250	Stainl. Steel	FKM	IF5020-75 RV
5/8"	G 3/4	36	71	16	17,7	40	27	250	Stainl. Steel	FKM	IF6320 RV
3/4"	G 3/4	46	77	16	22	50	30	250	Stainl. Steel	FKM	IF7520 RV
3/4"	G 1	46	83	18	22	50	30	250	Stainl. Steel	FKM	IF7520-100 RV
1"	G 1	55	93	20	23,3	60	36	200	Stainl. Steel	FKM	IF10020 RV
1"	G 1 1/4	55	89	18	23,3	60	36	200	Stainl. Steel	FKM	IF10020-125 RV

## Lubrication Nipple

## IF-Series

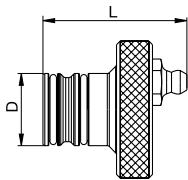

Body Size	Version	L mm	D mm	Part Number
3/8"	for coupling	39	20	GRIF38
1/2"	for coupling	42	25	GRIF50
5/8"	for coupling	43	27	GRIF63
3/4"	for coupling	48	30	GRIF75
1"	for coupling	54	36	GRIF100

## Seal-Kit

## IF-Series

Body Size	Version	Material	Part Number
1/8"	for plugs	NBR	IF2300-PSN
1/8"	for plugs	FKM	IF2300-PSV
1/4"	for plugs	NBR	IF2500-PSN
1/4"	for plugs	FKM	IF2500-PSV
1/4"	for plugs	EPDM	IF2500-PSEP
1/4"	for plugs	PUR	IF2500-PSPU
3/8"	for plugs	NBR	IF3800-PSN
3/8"	for plugs	FKM	IF3800-PSV
3/8"	for plugs	EPDM	IF3800-PSEP
3/8"	for plugs	PUR	IF3800-PSPU
1/2"	for plugs	NBR	IF5000-PSN
1/2"	for plugs	FKM	IF5000-PSV
1/2"	for plugs	EPDM	IF5000-PSEP
1/2"	for plugs	PUR	IF5000-PSPU
5/8"	for plugs	NBR	IF6300-PSN
5/8"	for plugs	FKM	IF6300-PSV
5/8"	for plugs	EPDM	IF6300-PSEP
5/8"	for plugs	PUR	IF6300-PSPU
3/4"	for plugs	NBR	IF7500-PSN
3/4"	for plugs	FKM	IF7500-PSV
3/4"	for plugs	EPDM	IF7500-PSEP
3/4"	for plugs	PUR	IF7500-PSPU
1"	for plugs	NBR	IF10000-PSN
1"	for plugs	FKM	IF10000-PSV
1"	for plugs	EPDM	IF10000-PSEP
1"	for plugs	PUR	IF10000-PSPU

# Dust Protection

# IF-Series

Body Size	Version	L mm	D mm	Material	Color	Part Number
1/8"	for coupling	145	19	PVC	Blue	IB3826
1/8"	for plug	145	19	PVC	Blue	IB2526
1/4"	for coupling	160	24	PVC	Black	PFE-251-P
1/4"	for coupling	160	24	PVC	Blue	IF2516
1/4"	for plug	160	23	PVC	Black	CFE-252-P
1/4"	for plug	160	23	PVC	Blue	IF2526
3/8"	for coupling	170	28	PVC	Black	PFE-371-P
3/8"	for coupling	170	28	PVC	Blue	IF3816
3/8"	for coupling	170	28	PVC	Red	IF3816 R
3/8"	for plug	170	28	PVC	Black	CFE-372-P
3/8"	for plug	170	28	PVC	Blue	IF3826
3/8"	for plug	170	28	PVC	Red	IF3826 R
1/2"	for coupling	185	35	PVC	Black	PFE-501-P
1/2"	for coupling	185	35	PVC	Blue	IF5016
1/2"	for plug	185	35	PVC	Black	CFE-502-P
1/2"	for plug	185	35	PVC	Blue	IF5026
5/8"	for coupling	215	37	PVC	Black	PFE-621-P
5/8"	for coupling	215	37	PVC	Blue	IF6316
5/8"	for plug	215	37	PVC	Black	CFE-622-P
5/8"	for plug	215	37	PVC	Blue	IF6326
3/4"	for coupling	185	42	PVC	Black	PFE-751-P
3/4"	for coupling	185	42	PVC	Blue	IF7516
3/4"	for plug	185	42	PVC	Black	CFE-752-P
3/4"	for plug	185	42	PVC	Blue	IF7526
1"	for coupling	240	50	PVC	Black	PFE-1001-P
1"	for coupling	240	50	PVC	Blue	IF10016
1"	for plug	240	50	PVC	Black	CFE-1002-P
1"	for plug	240	50	PVC	Blue	IF10026

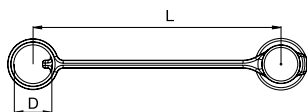

Further colors on request.

## Cross-Reference-List

### Coupling

Body Size	Version	Old Part Number	New Part Number	Page
1/8"	Standard	IF2310	FEM-121-2FB	39
1/4"	Standard	IF2510	FEM-251-4FB	39
1/4"	Standard	IF2510-38	FEM-251-6FB	39
3/8"	Standard	IF3810	FEM-371-6FB	39
3/8"	Standard	IF3810-50	FEM-371-8FB	39
3/8"	Standard	IF3810-50V	FEM-371-8FB-E4	39
1/2"	Standard	IF5010	FEM-501-8FB	39
1/2"	Standard	IF5010-75	FEM-501-12FB	39
5/8"	Standard	IF6310	FEM-621-12FB	39
3/4"	Standard	IF7510	FEM-751-12FB	39
3/4"	Standard	IF7510-100	FEM-751-16FB	39
1"	Standard	IF10010	FEM-1001-16FB	39
1"	Standard	IF10010-125	FEM-1001-20FB	39
1/4"	Press. Elimin.	IF2511	FEC-251-4FB	40
1/4"	Press. Elimin.	IF2511-38	FEC-251-6FB	40
3/8"	Press. Elimin.	IF3811	FEC-371-6FB	40
3/8"	Press. Elimin.	IF3811-50	FEC-371-8FB	40
1/2"	Press. Elimin.	IF5011	FEC-501-8FB	40
1/2"	Press. Elimin.	IF5011-75	FEC-501-12FB	40
5/8"	Press. Elimin.	IF6311	FEC-621-12FB	40
3/4"	Press. Elimin.	IF7511	FEC-751-12FB	40
3/4"	Press. Elimin.	IF7511-100	FEC-751-16FB	40
1"	Press. Elimin.	IF10011	FEC-1001-16FB	40
1"	Press. Elimin.	IF10011-125	FEC-1001-20FB	40
1/4"	for Multiplate	IF2510 E	FEMP-251-4FB	41
1/4"	for Multiplate	IF2510-38 E	FEMP-251-6FB	41
3/8"	for Multiplate	IF3810 E	FEMP-371-6FB	41
3/8"	for Multiplate	IF3810-50 E	FEMP-371-8FB	41
1/2"	for Multiplate	IF5010 E	FEMP-501-8FB	41
1/2"	for Multiplate	IF5010-75 E	FEMP-501-12FB	41
5/8"	for Multiplate	IF6310 E	FEMP-621-12FB	41
3/4"	for Multiplate	IF7510 E	FEMP-751-12FB	41
3/4"	for Multiplate	IF7510-100 E	FEMP-751-16FB	41
1"	for Multiplate	IF10010 E	FEMP-1001-16FB	41
1"	for Multiplate	IF10010-125 E	FEMP-1001-20FB	41

### Plug

Body Size	Version	Old Part Number	New Part Number	Page
1/8"	Standard	IF2320	FEM-122-2FB	39
1/4"	Standard	IF2520	FEM-252-4FB	39
1/4"	Standard	IF2520-38	FEM-252-6FB	39
3/8"	Standard	IF3820	FEM-372-6FB	39
3/8"	Standard	IF3820-50	FEM-372-8FB	39
3/8"	Standard	IF3820-50V	FEM-372-8FB-E4	39
1/2"	Standard	IF5020	FEM-502-8FB	39
1/2"	Standard	IF5020-50	FEM-502-12FB	39
5/8"	Standard	IF6320	FEM-622-12FB	39
3/4"	Standard	IF7520	FEM-752-12FB	39
3/4"	Standard	IF7520-100	FEM-752-16FB	39
1"	Standard	IF10020	FEM-1002-16FB	39
1"	Standard	IF10020-125	FEM-1002-20FB	39
1/4"	Press. Elimin.	IF2521	FEC-252-4FB	40
1/4"	Press. Elimin.	IF2521-38	FEC-252-6FB	40
3/8"	Press. Elimin.	IF3821	FEC-372-6FB	40
3/8"	Press. Elimin.	IF3821-50	FEC-372-8FB	40
1/2"	Press. Elimin.	IF5021	FEC-502-8FB	40
1/2"	Press. Elimin.	IF5021-75	FEC-502-12FB	40
5/8"	Press. Elimin.	IF6321	FEC-622-12FB	40
3/4"	Press. Elimin.	IF7521	FEC-752-12FB	40
3/4"	Press. Elimin.	IF7521-100	FEC-752-16FB	40
1"	Press. Elimin.	IF10021	FEC-1002-16FB	40
1"	Press. Elimin.	IF10021-125	FEC-1002-20FB	40
1/4"	for Multiplate	IF2520 E	FEMP-252-4FB	41
3/8"	for Multiplate	IF3820 E	FEMP-372-6FB	41
1/2"	for Multiplate	IF5020 E	FEMP-502-8FB	41
5/8"	for Multiplate	IF6320 E	FEMP-622-12FB	41
3/4"	for Multiplate	IF7520 E	FEMP-752-12FB	41
1"	for Multiplate	IF10020 E	FEMP-1002-16FB	41
1/4"	Press. El. for Multiplate	IF2521 E	FEC-252-4FB	41
1/4"	Press. El. for Multiplate	IF2521-38E	FEC-252-6FB	41
3/8"	Press. El. for Multiplate	IF3821 E	FEC-372-6FB	41
3/8"	Press. El. for Multiplate	IF3821-50E	FEC-372-8FB	41
1/2"	Press. El. for Multiplate	IF5021 E	FEC-502-8FB	41
1/2"	Press. El. for Multiplate	IF5021-75E	FEC-502-12FB	41
5/8"	Press. El. for Multiplate	IF6321 E	FEC-622-12FB	41
3/4"	Press. El. for Multiplate	IF7521 E	FEC-752-12FB	41
3/4"	Press. El. for Multiplate	IF7521-100E	FEC-752-16FB	41
1"	Press. El. for Multiplate	IF10021 E	FEC-1002-16FB	41
1"	Press. El. for Multiplate	IF10021-125E	FEC-1002-20FB	41





Body Size

1/4" to 2"

Tema Profile

T-Series

Medium Pressure



**Technical Description**

The TEMA Standard Series is characterised by a low pressure drop and maximum flow capacity. The coupling system is available as double shut-off or straight through version. The 2500 can be used also as a single shut-off version.

**Advantages**

High operating pressure.  
Compact dimension.  
Due to the Pressure Eliminator version for coupling and plug the connection is possible up to the operating pressure.  
Double safety through a double O-ring seal.  
A safety closing ring prevents unintentional uncoupling.

**Working Pressure**

See charts.

**Working Temperature**

-30°C up to +100°C (NBR)  
-25°C up to +200°C (FKM) depending on the medium.  
Special seals are available on request (see page 6 ff).

**Available Valves**

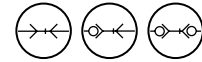

**Applications Area**



Material Coupling	Standard / Pressure Eliminator	Stainl. Steel / Press. Eli.	High Press. Water (3/8")
Coupling Body	Brass, nickel plated chromated	AISI 316	Brass, chromated
Sleeve	Steel hardened, zinc plated, passiv., sealed	AISI 316	Brass, chromated
Locking Ring	Brass, zinc-iron coated, black passiv., sealed	AISI 316	
Valve	Brass	AISI 316	
Springs	AISI 301	AISI 301	AISI 301
Locking Balls	AISI 420 C	AISI 420 C	AISI 420 C
Seals	NBR/FKM	FKM	NBR
Valve Holder (up to 100°C)	Zinc casting	AISI 316	
Valve Holder (over 100°C)	Brass	AISI 316	

  

Plug	Standard / Pressure Eliminator	Stainl. Steel / Press. Eli.	High Press. Water (3/8")
Plug Body	Steel hardened, zinc plated, passiv., sealed	AISI 316	AISI 420 hardened
Valve	Brass	AISI 316	
Springs	AISI 301	AISI 301	
Seals	NBR/FKM	FKM	
Valve Holder (up to 100°C)	Zinc Casting	AISI 316	
Valve Holder (over 100°C)	Brass	AISI 316	

**Flow Capacity with Oil with Viscosity of 32cSt at 40°C as per ISO 7241/2-2000**

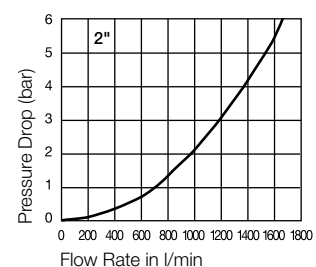
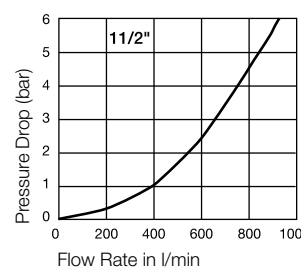
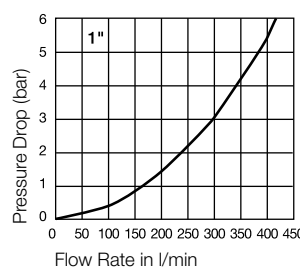
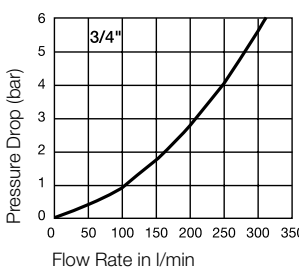
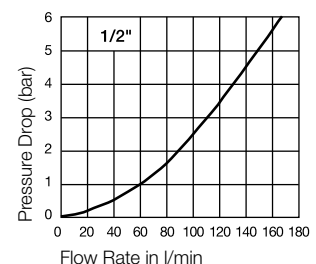
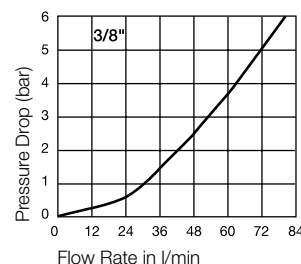
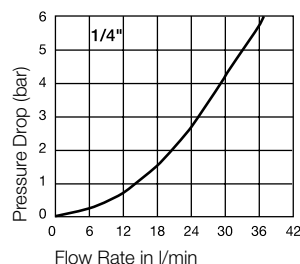
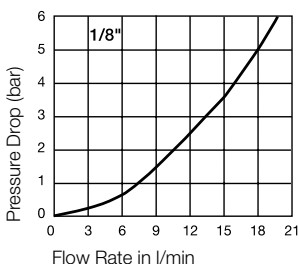

Body Size	Connec- tion A	Hex mm	L mm	D mm	Valve	Working Press. connect. in bar	Version	Seal	Part Number
1/8"	G 1/8	15	38	18	with	200	Standard	NBR	2310-QC
1/8"	G 1/8	15	38	18	with	200	Standard	FKM	2310 V
1/8"	G 1/8	15	38	18	without	200	Standard	NBR	2310 UV
1/8"	G 1/8	15	38	18	without	200	Standard	FKM	2310 VUV
1/4"	G 1/4	21	64	25	with	450	Standard	NBR	2510-QC
1/4"	G 1/4	21	64	25	with	450	Standard	FKM	2510 V
1/4"	G 1/4	21	64	25	without	450	Standard	NBR	2510 UV
1/4"	G 1/4	21	64	25	without	450	Standard	FKM	2510 VUV
3/8"	G 3/8	24	60	34	with	350	Standard	NBR	3810
3/8"	G 3/8	24	60	34	with	350	Standard	FKM	3810 V
3/8"	G 3/8	24	60	34	without	350	Standard	NBR	3810 UV
3/8"	G 3/8	24	60	34	without	350	Standard	FKM	3810 VUV
3/8"	G 3/8	24	60	34	without	350	High Press. Water	NBR	3810 H
3/8"	G 3/8	24	60	34	without	350	High Press. Water	FKM	3810 HV
3/8"	G 3/8	24	60	34	without	350	High Press. Water	EPDM	3810 HEP
3/8"	G 3/8	29	60	34	without	350	High Press. Water	NBR	3810 H2
3/8"	G 3/8	29	60	34	without	350	High Press. Water	FKM	3810 H2V
3/8"	G 3/8	29	60	34	without	350	High Press. Water	EPDM	3810 H2EP
1/2"	G 1/2	30	65	40	with	300	Standard	NBR	5010
1/2"	G 1/2	30	65	40	with	300	Standard	FKM	5010 V
1/2"	G 1/2	30	65	40	without	300	Standard	NBR	5010 UV
1/2"	G 1/2	30	65	40	without	300	Standard	FKM	5010 VUV
3/4"	G 3/4	38	73	52	with	280	Standard	NBR	7510
3/4"	G 3/4	38	73	52	with	280	Standard	FKM	7510 V
3/4"	G 3/4	38	73	52	without	280	Standard	NBR	7510 UV
3/4"	G 3/4	38	73	52	without	280	Standard	FKM	7510 VUV
1"	G 1	45	88	62	with	250	Standard	NBR	10010
1"	G 1	45	88	62	with	250	Standard	FKM	10010 V
1"	G 1	45	88	62	without	250	Standard	NBR	10010 UV
1"	G 1	45	88	62	without	250	Standard	FKM	10010 VUV
1 1/2"	G 1 1/2	60	112	73	with	200	Standard	NBR	15010-QC
1 1/2"	G 1 1/2	60	112	73	with	200	Standard	FKM	15010 V
1 1/2"	G 1 1/2	60	112	73	with	50	Brass	NBR	15010 M
1 1/2"	G 1 1/2	60	112	73	with	50	Brass	FKM	15010 MV
1 1/2"	G 1 1/2	60	112	73	without	200	Standard	NBR	15010 UV
1 1/2"	G 1 1/2	60	112	73	without	200	Standard	FKM	15010 VUV
1 1/2"	G 1 1/2	60	112	73	without	50	Brass	NBR	15010 MUV
1 1/2"	G 1 1/2	60	112	73	without	50	Brass	FKM	15010 MVUV
2"	G 2	75	144	90	with	180	Standard	NBR	20010-QC
2"	G 2	75	144	90	with	180	Standard	FKM	20010 V
2"	G 2	75	144	90	without	180	Standard	NBR	20010 UV
2"	G 2	75	144	90	without	180	Standard	FKM	20010 VUV

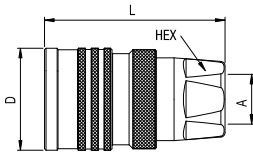

Female Thread

# Plugs

# T-Series Standard

Body Size	Connection A	Hex mm	L mm	D mm	Valve	Working Press. connect. in bar	Version	Seal	Part Number
1/8"	G 1/8	15	36	17	with	200	Standard	NBR	2320
1/8"	G 1/8	15	38	17	with	200	Standard	FKM	2320 V
1/8"	G 1/8	15	36	17	without	200	Standard		2320 UV
1/4"	G 1/4	19	45	21	with	450	Standard	NBR	2520
1/4"	G 1/4	19	45	21	with	450	Standard	FKM	2520 V
1/4"	G 1/4	19	45	21	without	450	Standard		2520 UV
3/8"	G 3/8	22	42	24	with	350	Standard	NBR	3820
3/8"	G 3/8	22	42	24	with	350	Standard	FKM	3820 V
3/8"	G 3/8	22	38	24	without	350	Standard		3820 UV
1/2"	G 1/2	27	46	30	with	320	Standard	NBR	5020
1/2"	G 1/2	27	46	30	with	320	Standard	FKM	5020 V
1/2"	G 1/2	27	42	30	without	320	Standard		5020 UV
3/4"	G 3/4	36	52	39	with	300	Standard	NBR	7520-QC
3/4"	G 3/4	36	52	39	with	300	Standard	FKM	7520 V
3/4"	G 3/4	36	47	39	without	300	Standard		7520 UV
1"	G 1	46	60	49	with	280	Standard	NBR	10020-QC
1"	G 1	46	60	49	with	280	Standard	FKM	10020 V
1"	G 1	46	53	49	without	280	Standard		10020 UV
1 1/2"	G 1 1/2	60	107	67	with	200	Standard	NBR	15020
1 1/2"	G 1 1/2	60	107	67	with	200	Standard	FKM	15020 V
1 1/2"	G 1 1/2	60	107	67	with	50	Brass	NBR	15020 M
1 1/2"	G 1 1/2	60	107	67	with	50	Brass	FKM	15020 MV
1 1/2"	G 1 1/2	60	107	67	without	200	Standard		15020 UV
1 1/2"	G 1 1/2	60	107	67	without	50	Brass		15020 MUUV
2"	G 2	75	142	85	with	180	Standard	NBR	20020-QC
2"	G 2	75	142	85	with	180	Standard	FKM	20020 V
2"	G 2	75	142	85	without	180	Standard	NBR	20020 UV

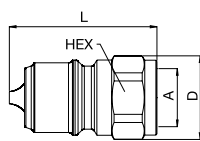

Female Thread

# Super Nipple

# T-Series Standard

Body Size	Connection A	Hex mm	L mm	D mm	Valve	Working Press. connect. in bar	Version	Seal	Part Number
3/4"	G 3/4	36	52	39	with	300	Standard	NBR	7520 S

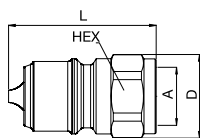

Female Thread

## Couplings

## T-Series Pressure Eliminator

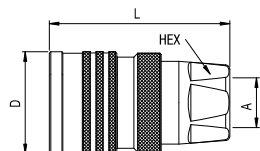

Female Thread

Body Size	Connec-tion A	Hex mm	L mm	D mm	Valve	Working Press. connect. in bar	Version	Seal	Part Number
3/8"	G 3/8	24	60	34	with	350	Press. Eliminator	NBR	3811
3/8"	G 3/8	24	60	34	with	350	Press. Eliminator	FKM	3811 V
1/2"	G 1/2	30	65	40	with	300	Press. Eliminator	NBR	5011
1/2"	G 1/2	30	65	40	with	300	Press. Eliminator	FKM	5011 V
3/4"	G 3/4	38	72	52	with	280	Press. Eliminator	NBR	7511
3/4"	G 3/4	38	72	52	with	280	Press. Eliminator	FKM	7511 V
1"	G 1	45	88	62	with	250	Press. Eliminator	NBR	10011-QC
1"	G 1	45	88	62	with	250	Press. Eliminator	FKM	10011 V
1 1/2"	G 1 1/2	60	112	73	with	200	Press. Eliminator	NBR	15011-QC
1 1/2"	G 1 1/2	60	112	73	with	200	Press. Eliminator	FKM	15011 V

## Plugs

## T-Series Pressure Eliminator

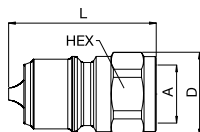

Female Thread

Body Size	Connec-tion A	Hex mm	L mm	D mm	Valve	Working Press. connect. in bar	Version	Seal	Part Number
3/8"	G 3/8	22	43	24	with	350	Press. Eliminator	NBR	3821
3/8"	G 3/8	22	43	24	with	350	Press. Eliminator	FKM	3821 V
1/2"	G 1/2	27	47	30	with	320	Press. Eliminator	NBR	5021-QC
1/2"	G 1/2	27	47	30	with	320	Press. Eliminator	FKM	5021 V
3/4"	G 3/4	36	53	39	with	300	Press. Eliminator	NBR	7521-QC
3/4"	G 3/4	36	53	39	with	300	Press. Eliminator	FKM	7521 V
1"	G 1	46	61	49	with	280	Press. Eliminator	NBR	10021
1"	G 1	46	61	49	with	280	Press. Eliminator	FKM	10021 V
1 1/2"	G 1 1/2	60	107	67	with	200	Press. Eliminator	NBR	15021
1 1/2"	G 1 1/2	60	107	67	with	200	Press. Eliminator	FKM	15021 V

## Super Nipple

## T-Series Pressure Eliminator

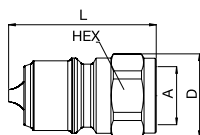

Female Thread

Body Size	Connec-tion A	Hex mm	L mm	D mm	Valve	Working Press. connect. in bar	Version	Seal	Part Number
3/4"	G 3/4	36	52	39	with	300	Press. Eliminator	NBR	7521 S

## Couplings

## T-Series Stainless Steel

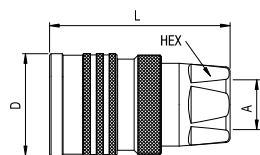

Female Thread

Body Size	Connection A	Hex mm	L mm	D mm	Valve	Working Press. connect. in bar <sup>4</sup>	Version	Seal	Part Number
1/8"	G 1/8	15	38	18	with	200	Stainless Steel	FKM	2310 RV
1/8"	G 1/8	15	38	18	with	200	Stainless Steel	FKM	2310 RFV <sup>1</sup>
1/8"	G 1/8	15	38	18	without	200	Stainless Steel	FKM	2310 RVUV
1/4"	G 1/4	21	64	25	with	250	Stainless Steel	FKM	2510 RV
1/4"	G 1/4	21	64	25	without	250	Stainless Steel	FKM	2510 RVUV
3/8"	G 3/8	24	60	34	with	300	Stainless Steel	FKM	3810 RV
3/8"	G 3/8	24	60	34	without	350	Stainless Steel	FKM	3810 RVUV
1/2"	G 1/2	30	65	40	with	300	Stainless Steel	FKM	5010 RV
1/2"	G 1/2	30	65	40	without	300	Stainless Steel	FKM	5010 RVUV
3/4"	G 3/4	38	73	52	with	250	Stainless Steel	FKM	7510 RV
3/4"	G 3/4	38	73	52	without	250	Stainless Steel	FKM	7510 RVUV
1"	G 1	45	88	62	with	250	Stainless Steel	FKM	10010 RV
1"	G 1	45	88	62	without	250	Stainless Steel	FKM	10010 RVUV
1 1/2"	G 1 1/2	60	112	73	with	150	Stainless Steel	FKM	15010 RV
1 1/2"	G 1 1/2	60	112	73	without	150	Stainless Steel	FKM	15010 RVUV
2"	G 2	75	144	90	with	120	Stainless Steel	FKM	20010 RV
2"	G 2	75	144	90	without	120	Stainless Steel	FKM	20010 RVUV

## Plugs

## T-Series Stainless Steel

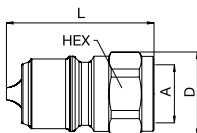

Female Thread

Body Size	Connection A	Hex mm	L mm	D mm	Valve	Working Press. connect. in bar <sup>4</sup>	Version	Seal	Part Number
1/8"	G 1/8	15	36	17	with	200	Stainless Steel	FKM	2320 RV
1/8"	G 1/8	15	38	17	with	200	Stainless Steel	FKM	2320 RFV <sup>1</sup>
1/8"	G 1/8	15	36	17	without	200	Stainless Steel		2320 RUV
1/4"	G 1/4	19	45	21	with	250	Stainless Steel	FKM	2520 RV
1/4"	G 1/4	19	45	21	with	250	Stainless Steel	FKM	2520 RFV <sup>1</sup>
1/4"	G 1/4	19	45	21	with	170	High Press. Water	FKM	2520 RFV2 <sup>1 3</sup>
1/4"	G 1/4	19	45	21	without	250	Stainless Steel		2520 RUH
1/4"	G 1/4	19	45	21	without	450	Stainless Steel		2520 RHUV <sup>2</sup>
1/4"	G 1/4	19	45	21	without	170	Stainless Steel		2520 RFUV2 <sup>2</sup>
3/8"	G 3/8	22	42	24	with	300	Stainless Steel	FKM	3820 RV
3/8"	G 3/8	22	42	24	with	300	Stainless Steel	NBR	3820 RF <sup>1</sup>
3/8"	G 3/8	22	42	24	with	300	Stainless Steel	FKM	3820 RFV <sup>1</sup>
3/8"	G 3/8	22	38	24	without	300	Stainless Steel		3820 RUV
3/8"	G 3/8	22	38	24	without	170	Stainless Steel		3820 RFUV <sup>2</sup>
1/2"	G 1/2	27	46	30	with	300	Stainless Steel	FKM	5020 RV
1/2"	G 1/2	27	42	30	without	300	Stainless Steel		5020 RUV
3/4"	G 3/4	36	52	39	with	250	Stainless Steel	FKM	7520 RV
3/4"	G 3/4	36	47	39	without	250	Stainless Steel		7520 RUV
1"	G 1	46	60	49	with	250	Stainless Steel	FKM	10020 RV
1"	G 1	46	53	49	without	250	Stainless Steel		10020 RUV

## Plugs

## T-Series Stainless Steel

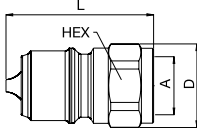
	Body Size	Conne- tion A	Hex mm	L mm	D mm	Valve	Working Press. connect. in bar <sup>4</sup>	Version	Seal	Part Number
 <p>Female Thread</p>	1 1/2"	G 1 1/2	60	107	67	with	150	Stainless Steel	FKM	15020 RV
	1 1/2"	G 1 1/2	60	107	67	without	150	Stainless Steel		15020 RUV
	2"	G 2	75	142	85	with	120	Stainless Steel	FKM	20020 RV
	2"	G 2	75	142	85	without	120	Stainless Steel		20020 RUV

## Couplings

## T-Series Stainless Steel Pressure Eliminator

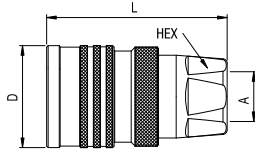
	Body Size	Conne- tion A	Hex mm	L mm	D mm	Valve	Working Press. connect. in bar <sup>4</sup>	Version	Seal	Part Number
 <p>Female Thread</p>	3/8"	G 3/8	24	60	34	with	300	Press. Eliminator	FKM	3811 RV
	3/8"	G 3/8	24	60	34	with	300	Press. Eliminator	FKM	3811 RFV <sup>1</sup>
	1/2"	G 1/2	30	65	40	with	300	Press. Eliminator	FKM	5011 RV
	1/2"	G 1/2	30	65	40	with	300	Press. Eliminator	FKM	5011 RFV <sup>1</sup>
	3/4"	G 3/4	38	72	52	with	250	Press. Eliminator	FKM	7511 RV
	3/4"	G 3/4	38	72	52	with	250	Press. Eliminator	FKM	7511 RFV <sup>1</sup>
	1"	G 1	45	88	62	with	250	Press. Eliminator	FKM	10011 RV
	1"	G 1	45	88	62	with	250	Press. Eliminator	FKM	10011 RFV

## Plugs

## T-Series Stainless Steel Pressure Eliminator

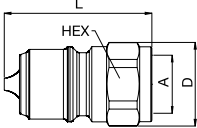
	Body Size	Conne- tion A	Hex mm	L mm	D mm	Valve	Working Press. connect. in bar <sup>4</sup>	Version	Seal	Part Number
 <p>Female Thread</p>	3/8"	G 3/8	22	43	24	with	350	Press. Eliminator	FKM	3821 RV
	3/8"	G 3/8	22	43	24	with	350	Press. Eliminator	FKM	3821 RFV
	1/2"	G 1/2	27	47	30	with	300	Press. Eliminator	FKM	5021 RV
	1/2"	G 1/2	27	47	30	with	300	Press. Eliminator	FKM	5021 RFV <sup>1</sup>
	3/4"	G 3/4	36	53	39	with	250	Press. Eliminator	FKM	7521 RV
	3/4"	G 3/4	36	53	39	with	250	Press. Eliminator	FKM	7521 RFV <sup>1</sup>
	1"	G 1	46	61	49	with	250	Press. Eliminator	NBR	10021 RV
	1"	G 1	46	61	49	with	250	Press. Eliminator	FKM	10021 RFV <sup>1</sup>

<sup>1</sup> Valve made of brass

<sup>2</sup> Material: AISI 420 hardened

<sup>3</sup> Suitable for high pressure water, AISI 303

<sup>4</sup> For pulsating pressure, the pressure must not exceed 50% of the given value

## Lubrication Nipples

## T-Series

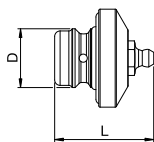

Body Size	Version	L mm	D mm	Part Number
3/8"	for coupling	36	22	GR3-QC
1/2"	for coupling	41	25	GR5
3/4"	for coupling	44	33	GR7
1"	for coupling	46	41	GR10-QC

For problem free operating with longer lifetime – especially in cold climates.

## Seal-Kit

## T-Series

Body Size	Version	Material	Part Number
1/8"	for coupling	NBR	11310 N
1/8"	for coupling	FKM	11310 V
1/4"	for coupling	NBR	2500-PSN
1/4"	for coupling	FKM	2500-PSV
3/8"	for coupling	NBR	3800-PSN
3/8"	for coupling	FKM	3800-PSV
1/2"	for coupling	NBR	5000-PSN
1/2"	for coupling	FKM	5000-PSV
3/4"	for coupling	NBR	7500-PSN
3/4"	for coupling	FKM	7500-PSV
1"	for coupling	NBR	10000-PSN
1"	for coupling	FKM	10000-PSV
1 1/2"	for coupling	NBR	15000-PSN
1 1/2"	for coupling	FKM	15000-PSV
2"	for coupling	NBR	20000-PSN
2"	for coupling	FKM	20000-PSV

The valve seal is crimped and can not be changed.



## Dust Protection

Body Size	Version	L mm	D mm	Material	Color	Part Number
1/8"	for coupling	55	15	PVC	Red	2315-QC
1/8"	for plug	55	15	PVC	Red	125-QC
1/4"	for coupling	145	44	PVC	Blue	2516-QC
1/4"	for plug	145	42	PVC	Blue	2526-QC
3/8"	for coupling	145	54	PVC	Blue	3816-QC
3/8"	for plug	145	46	PVC	Blue	3826
3/8"	for coupling	145	54	PVC	Yellow	3816 Y
3/8"	for plug	145	46	PVC	Yellow	3826 Y
1/2"	for coupling	170	60	PVC	Blue	5016-QC
1/2"	for plug	170	52	PVC	Blue	5026-QC
3/4"	for coupling	195	76	PVC	Blue	7516-QC
3/4"	for plug	195	63	PVC	Blue	7526
1"	for coupling	230	90	PVC	Blue	10016
1"	for plug	230	76	PVC	Blue	10026
1 1/2"	for coupling	310	56	PVC	Black	15015
1 1/2"	for plug	300	56	PVC	Black	15025
2"	for coupling	380	63	EBA	Black	20015-QC
2"	for plug	380	63	EBA	Black	20025-QC

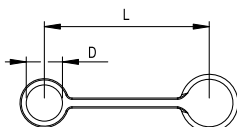

When coupling and plug is connected it is recommended to connect dust protections – to keep these clean, too. Further colors on request.



Body Size

1/2" to 1"

Tema Profile

H-Series



## Applications Area



Body Size	Bursting Pressure connected
1/2"	> 1200 bar
3/4"	> 1200 bar
1"	> 1200 bar

## Technical Description

The H series is a further development of the standard hydraulic coupling, with some new materials to stand up to heavy conditions. The body of the coupling is made of steel so that the coupling functions reliably even when subject to substantial lateral forces and high impulses.

## Advantages

High flow rate – minimum pressure drop. Twice as safe through double sealing. Safety closing ring prevents unintentional uncoupling. Maximum protection against corrosion. Small dimensions. Pressure eliminator for coupling and plug available. Possible to connect up to working pressure.

## Working Pressure

See charts.

## Working Temperature

-30°C up to +100°C (NBR)  
-25°C up to +200°C (FKM)  
depending on the medium.  
Special seals are available on request (see page 6 ff).

## Available Valves

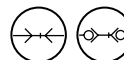

Material Coupling	Standard / Pressure Eliminator
Coupling Body	Steel, zinc plated, passivated, sealed
Sleeve	Steel hardened, zinc plated, passivated, sealed
Locking Ring	Brass, zinc-iron coated, black passivated, sealed
Valve	Brass
Springs	AISI 302
Locking Balls	AISI 420 C
Seals	NBR/FKM
Valve Holder	Brass, hard-drawn

  

Plug	Standard / Pressure Eliminator
Plug Body	Steel hardened, zinc plated, passivated, sealed
Valve	Brass
Springs	AISI 301
Seals	NBR/FKM
Valve Holder	Brass, hard-drawn

## Flow Capacity with Oil with Viscosity of 32cSt at 40°C as per ISO 7241/2-2000

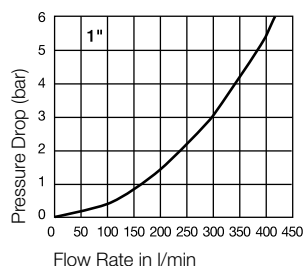
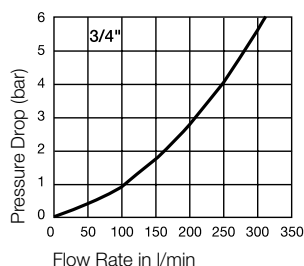
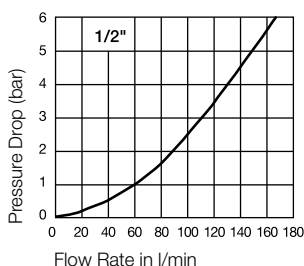

**Couplings****H-Series Standard**

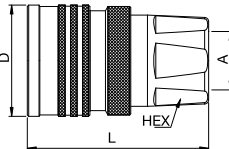
	Body Size	Connection A	Hex mm	L mm	D mm	Valve	Working Press. connect. in bar	Version	Seal	Part Number
 <p>Female Thread</p>	1/2"	G 1/2	30	65	40	with	320	Standard	NBR	H5010
	1/2"	G 1/2	30	65	40	with	320	Standard	FKM	H5010 V
	3/4"	G 3/4	38	73	52	with	300	Standard	NBR	H7510
	3/4"	G 3/4	38	73	52	with	300	Standard	FKM	H7510 V
	1"	G 1	45	88	62	with	280	Standard	NBR	H10010
	1"	G 1	45	88	62	with	280	Standard	FKM	H10010 V

**Plugs****H-Series Standard**

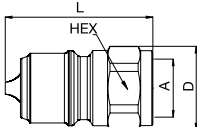
	Body Size	Connection A	Hex mm	L mm	D mm	Valve	Working Press. connect. in bar	Version	Seal	Part Number
 <p>Female Thread</p>	1/2"	G 1/2	27	46	30	with	320	Standard	NBR	5020
	1/2"	G 1/2	27	46	30	with	320	Standard	FKM	5020 V
	3/4"	G 3/4	36	52	39	with	300	Standard	NBR	7520-QC
	3/4"	G 3/4	36	52	39	with	300	Standard	FKM	7520 V
	1"	G 1	46	60	49	with	280	Standard	NBR	10020-QC
	1"	G 1	46	60	49	with	280	Standard	FKM	10020 V

**Super Nipple****H-Series Standard**

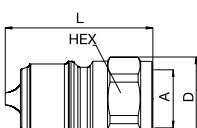
	Body Size	Connection A	Hex mm	L mm	D mm	Valve	Working Press. connect. in bar	Version	Seal	Part Number
 <p>Female Thread</p>	3/4"	G 3/4	36	52	39	with	300	Standard	NBR	7520 S

## Couplings

## H-Series Pressure Eliminator

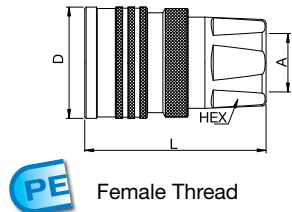

Body Size	Connection A	Hex mm	L mm	D mm	Valve	Working Press. connect. in bar	Version	Seal	Part Number
1/2"	G 1/2	30	65	40	with	320	Press. Eliminator	NBR	H5011
1/2"	G 1/2	30	65	40	with	320	Press. Eliminator	FKM	H5011 V
3/4"	G 3/4	38	72	52	with	300	Press. Eliminator	NBR	H7511
3/4"	G 3/4	38	72	52	with	300	Press. Eliminator	FKM	H7511 V
1"	G 1	45	88	62	with	280	Press. Eliminator	NBR	H10011
1"	G 1	45	88	62	with	280	Press. Eliminator	FKM	H10011 V

## Plugs

## H-Series Pressure Eliminator

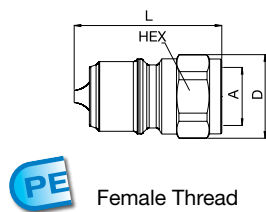

Body Size	Connection A	Hex mm	L mm	D mm	Valve	Working Press. connect. in bar	Version	Seal	Part Number
1/2"	G 1/2	27	47	30	with	320	Press. Eliminator	NBR	5021-QC
1/2"	G 1/2	27	47	30	with	320	Press. Eliminator	FKM	5021 V
3/4"	G 3/4	36	52	39	with	300	Press. Eliminator	NBR	7521-QC
3/4"	G 3/4	36	52	39	with	300	Press. Eliminator	FKM	7521 V
1"	G 1	46	61	49	with	280	Press. Eliminator	NBR	10021
1"	G 1	46	61	49	with	280	Press. Eliminator	FKM	10021 V

## Super Nipple

## H-Series Pressure Eliminator

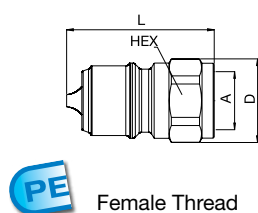

Body Size	Connection A	Hex mm	L mm	D mm	Valve	Working Press. connect. in bar	Version	Seal	Part Number
3/4"	G 3/4	36	52	39	with	300	Press. Eliminator	NBR	7521 S





Body Size

1/4" to 1"

Tema Profile

FF-Series

**Connected length in total**

FF2510 + FF2520 = 122 mm

FF2510 + FF2521 = 147 mm

FF3810 + FF3820 = 125 mm

FF3810 + FF3821 = 154 mm

FF5010 + FF5020 = 144 mm

FF5010 + FF5021 = 179 mm

FF7510 + FF7520 = 169 mm

FF7510 + FF7521 = 215 mm

FF10010 + FF10020 = 230 mm

FF10010 + FF10021 = 269 mm

**Body Size**    **Bursting Pressure connected**

1/4"    &gt; 3200 bar

3/8"    &gt; 2000 bar

1/2"    &gt; 1500 bar

3/4"    &gt; 1500 bar

1"    &gt; 1100 bar

**Applications Area****Technical Description**

The coupling system of the FF series has double shut-off, dry break and single-handed operation. During disconnection there is no oil loss, and during coupling there is no inclusion of air into the system.

**Advantages**

Dry break quick connect coupling. With minimum pressure drop. Single-handed operation. No oil loss during disconnection. A safety closing ring prevents unintentional disconnection. Twice as safe through double sealing. Also available with pressure eliminator, i.e. connection is possible under static/residual pressure up to working pressure.

**Working Pressure**

See charts.

**Working Temperature**

-30°C up to +100°C (NBR)  
-25°C up to +200°C (FKM)  
depending on the medium.  
Special seals are available on request (see page 6).

**Available Valves**

Material Coupling	Standard / Pressure Eliminator
Coupling Body	Steel, nitrocarburizing
Sleeve	Steel hardened, zinc plated, passivated, sealed
Looking Ring	Brass, zinc-iron coated, black passivated, sealed
Valve	Steel, zinc plated, passivated, sealed
Springs	AISI 301
Locking Balls	AISI 420 C
Seals	NBR/PUR
Valve Holder	Steel, yellow zinc plated, sealed
Thread Body	Steel, zinc plated, passivated, sealed
Plug	Standard / Pressure Eliminator
Plug Body	Steel hardened, zinc plated, passivated, sealed
Valve	Steel, nitrocarburizing
Springs	AISI 301
Seals	NBR/PUR
Valve Holder	Brass, hard-drawn
Thread Body	Steel, zinc plated, passivated, sealed

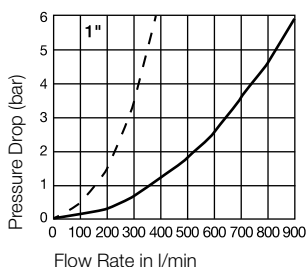
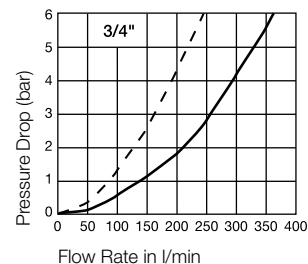
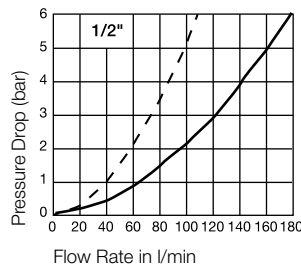
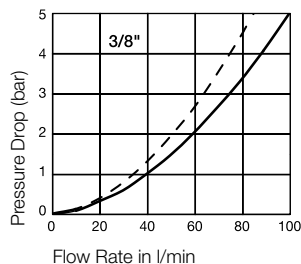
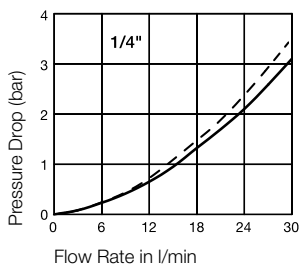
**Flow Capacity with Oil with Viscosity of 32cSt at 40°C as per ISO 7241/2-2000**

— Standard FF  
- - - Plug side pressure eliminator

## Couplings

## FF-Series Standard

Body Size	Connection A	Hex mm	L mm	D mm	Working Press. connect. in bar	Version	Seal	Part Number
1/4"	G 1/4	27	65	30	800	Standard	NBR/PUR	FF2510
3/8"	G 3/8	36	76,5	40	500	Standard	NBR/PUR	FF3810
1/2"	G 1/2	40	82	44	400	Standard	NBR/PUR	FF5010 C
1/2"	G 1/2	40	82	44	400	Standard	FKM	FF5010 CV
1/2"	G 3/4	40	82	44	400	Standard	NBR/PUR	FF5010-75 C
1/2"	G 3/4	40	82	44	400	Standard	FKM	FF5010-75 CV
3/4"	G 3/4	50	98	55	400	Standard	NBR/PUR	FF7510 C
3/4"	G 3/4	50	98	55	400	Standard	FKM	FF7510 CV
3/4"	G 1	50	106	55	400	Standard	NBR/PUR	FF7510-100 C
3/4"	G 1	50	106	55	400	Standard	FKM	FF7510-100 CV
1"	G 1	65	120	70	300	Standard	NBR/PUR	FF10010 C
1"	G 1	65	120	70	300	Standard	FKM	FF10010 CV
1"	G 1 1/4	65	120	70	300	Standard	NBR/PUR	FF10010-125 C
1"	G 1 1/4	65	120	70	300	Standard	FKM	FF10010-125 CV
1"	G 1 1/2	65	120	70	300	Standard	NBR/PUR	FF10010-150 C
1"	G 1 1/2	65	120	70	300	Standard	FKM	FF10010-150 CV

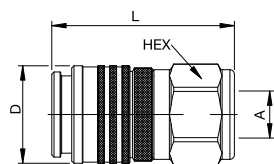

Female Thread

## Plugs

## FF-Series Standard

Body Size	Connection A	Hex mm	L mm	D mm	Working Press. connect. in bar	Version	Seal	Part Number
1/4"	G 1/4	25	74	28	800	Standard	NBR/PUR	FF2520
3/8"	G 3/8	32	69	35	500	Standard	NBR/PUR	FF3820
1/2"	G 1/2	36	84	35	400	Standard	NBR/PUR	FF5020 C
1/2"	G 1/2	36	84	35	400	Standard	FKM	FF5020 CV
1/2"	G 3/4	36	90	40	400	Standard	NBR/PUR	FF5020-75 C
1/2"	G 3/4	36	90	40	400	Standard	FKM	FF5020-75 CV
3/4"	G 3/4	41	101	45	400	Standard	NBR/PUR	FF7520 C
3/4"	G3/4	41	101	45	400	Standard	FKM	FF7520 CV
3/4"	G 1	50	112	55	400	Standard	NBR/PUR	FF7520-100 C
3/4"	G 1	50	112	55	400	Standard	FKM	FF7520-100 CV
1"	G 1	60	138	65	300	Standard	NBR/PUR	FF10020 C
1"	G 1	60	138	65	300	Standard	FKM	FF10020 CV
1"	G 1 1/4	60	138	70	300	Standard	NBR/PUR	FF10020-125 C
1"	G 1 1/4	60	138	70	300	Standard	FKM	FF10020-125 CV
1"	G 1 1/2	60	138	70	300	Standard	NBR/PUR	FF10020-150 C
1"	G 1 1/2	60	138	70	300	Standard	FKM	FF10020-150 CV

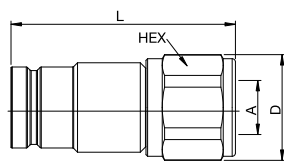

Female Thread

## Plugs

## FF-Series Pressure Eliminator

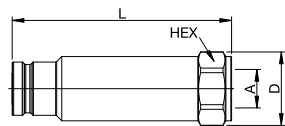

Female Thread

Body Size	Connection A	Hex mm	L mm	D mm	D1 mm	Working Press. connect. in bar	Version	Seal	Part Number
1/4"	G 1/4	25	99	28		800	Press. Eliminator	NBR/PUR	FF2521
3/8"	G 3/8	32	98	35		500	Press. Eliminator	NBR/PUR	FF3821
1/2"	G 1/2	36	120	40		400	Press. Eliminator	NBR/PUR	FF5021 C
1/2"	G 1/2	36	120	40		400	Press. Eliminator	FKM	FF5021 CV
3/4"	G 3/4	50	146	56		400	Press. Eliminator	NBR/PUR	FF7521 C
1"	G 1	55	178	60		300	Press. Eliminator	NBR/PUR	FF10021 C

## Couplings

## FF-Series for Multiplate

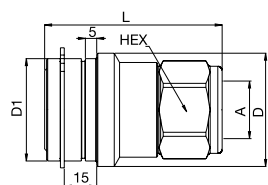

Female Thread

Body Size	Connection A	Hex mm	L mm	D mm	D1 mm	Working Press. connect. in bar	Version	Seal	Part Number
1/2"	G 1/2	40	82	52	47	400	for Multiplate	NBR/PUR	FF5010 CE
1/2"	G 1/2	40	82	52	47	400	for Multiplate	FKM	FF5010 CEV
3/4"	G 3/4	50	98	66	60	400	for Multiplate	NBR/PUR	FF7510 CE
3/4"	G 3/4	50	98	66	60	400	for Multiplate	FKM	FF7510 CEV

## Plugs

## FF-Series Pressure Eliminator for Multiplate

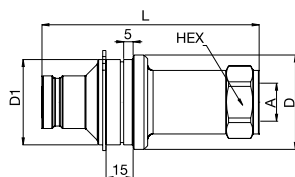

Female Thread

Body Size	Connection A	Hex mm	L mm	D mm	D1 mm	Working Press. connect. in bar	Version	Seal	Part Number
1/2"	G 1/2	36	120	52	47	400	Press. El. f. Multiplate	NBR/PUR	FF5021 CE
3/4"	G 3/4	50	146	66	60	400	Press. El. f. Multiplate	NBR/PUR	FF7521 CE

## Lubrication Nipples

## FF-Series

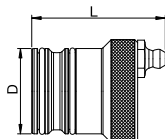

Body Size	Version	L mm	D mm	Part Number
1/2"	for coupling	48	29	GRF5
3/4"	for coupling	52	38	GRF7
1"	for coupling	52	50	GRF10



## Seal-Kit

## FF-Series

Body Size	Version	Material	Part Number
1/4"	for plugs	NBR	FF2500-PSNPU
3/8"	for plugs	NBR	FF3800-PSNPU
1/2"	for plugs	NBR	FF5000-PSNPU
1/2"	for plugs	FKM	FF5000-PSV
3/4"	for plugs	NBR	FF7500-PSNPU
3/4"	for plugs	FKM	FF7500-PSV
1"	for plugs	NBR	FF10000-PSNPU
1"	for plugs	FKM	FF10000-PSV

## Dust Protection

## FF-Series

Body Size	Version	L mm	D mm	Material	Color	Part Number
1/4"	for coupling	190	24	PVC	Blue	FF2516
1/4"	for plug	190	24	PVC	Blue	FF2526
3/8"	for coupling	190	28	PVC	Blue	FF3816
3/8"	for plug	190	28	PVC	Blue	FF3826
1/2"	for coupling	220	28	PVC	Blue	FF5016
1/2"	for plug	220	28	PVC	Blue	FF5026
3/4"	for coupling	250	42	PVC	Blue	FF7516
3/4"	for plug	250	42	PVC	Blue	FF7526
1"	for coupling	290	51	PVC	Blue	FF10016
1"	for plug	290	51	PVC	Blue	FF10026



Further colors on request.



Body Size

1/4" up to 3/4"

Parker Profile

SM-Series



**Technical Description**

Standard design with ball locking mechanism for high pressure applications. Rugged construction.

**Advantages**

Body size 1/2" and above feature PTFE back up ring which prevents seal washout at high flow rates. Solid steel bar-stock construction: induction-hardened for a coupling with maximum resistance to damage to hydraulic and mechanical shock and brinelling.

A poppet with a crimped seal assures a maximum sealing at low flow rates and prevents seal washout at high flow rates.

**Applications**

- Mobile equipment
- Industrial maintenance

**Working Temperature**

-40°C up to + 110°C (NBR) depending on the medium. Special seals are available on request (see page 6 ff).

**Working Pressure**

Body Size	Max. Operating Pressure connected
1/4"	410 bar
1/2"	410 bar
3/4"	310 bar

Material Coupling	Steel
Coupling Body	Steel
Sleeve	Steel
Back-up Ring	PTFE
Valve	Steel
Springs	Steel
Locking Balls	Steel
Seals	NBR
Valve Holder	Steel
Material Plug	Steel
Plug Body	Steel
Valve	Steel
Springs	Steel
Seals	NBR
Valve Holder	Steel

**Flow Capacity with Oil with Viscosity of 43cSt at 38°C as per ISO 7241/2-2000**

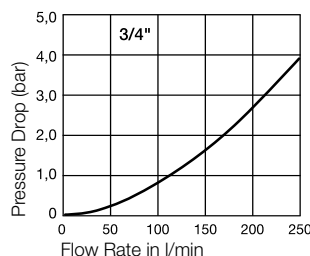
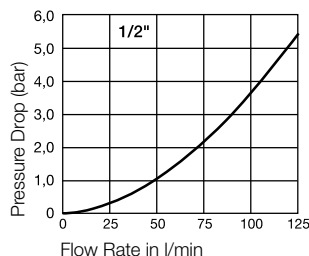
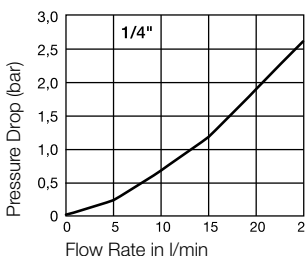

## Couplings

## SM-Series

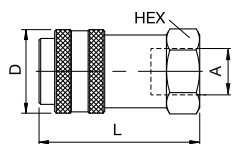

Female Thread

Body Size	Connection A	Thread	Hex	L mm	L1* mm	D mm	Version	Weight gr.	Part Number
1/4"	1/4"	BSPP	3/4"	56,9		26,9	Steel	118	SM-251-4FB
1/4"	1/4" - 18	NPTF	3/4"	53,1		26,9	Steel	110	SM-251-4FP
1/4"	3/8"	BSPP	15/16"	56,9		26,9	Steel	118	SM-251-6FB
1/4"	3/8" - 18	NPTF	15/16"	56,9		26,9	Steel	123	SM-251-6FP
1/2"	1/2"	BSPP	1 1/4"	76,2		39,6	Steel	336	SM-501-8FB
1/2"	1/2" - 14	NPTF	1 1/4"	76,2		39,6	Steel	319	SM-501-8FP
1/2"	3/4"	BSPP	1 3/8"	80,3		39,6	Steel	386	SM-501-12FB
1/2"	3/4" - 14	NPTF	1 3/8"	78		39,6	Steel	381	SM-501-12FP
3/4"	3/4"	BSPP	1 5/8"	98,8		56,4	Steel	853	SM-751-12FB
3/4"	3/4" - 14	NPTF	1 5/8"	95,8		56,4	Steel	822	SM-751-12FP
3/4"	1"	BSPP	1 5/8"	101,1		56,4	Steel	857	SM-751-16FB
3/4"	1" - 11 1/2	NPTF	1 5/8"	101,1		56,4	Steel	838	SM-751-16FP

## Plugs

## SM-Series

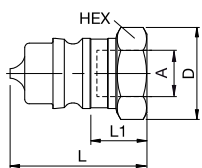





Female Thread

Body Size	Connection A	Thread	Hex	L mm	L1* mm	D mm	Version	Weight gr.	Part Number
1/4"	1/4"	BSPP	3/4"	41,7	21,6	22,1	Steel	41	SM-252-4FB
1/4"	1/4" - 18	NPTF	3/4"	37,8	17,8	22,1	Steel	33	SM-252-4FP
1/4"	3/8"	BSPP	15/16"	41,7	25,7	27,4	Steel	41	SM-252-6FB
1/4"	3/8" - 18	NPTF	15/16"	41,7	25,7	27,4	Steel	67	SM-252-6FP
1/2"	1/2"	BSPP	1 1/16"	51,1	16,5	31,2	Steel	82	SM-502-8FB
1/2"	1/2" - 14	NPTF	1 1/16"	51,1	23,4	31,2	Steel	70	SM-502-8FP
1/2"	3/4"	BSPP	1 3/8"	66,8	27,9	40,4	Steel	156	SM-502-12FB
1/2"	3/4" - 14	NPTF	1 3/8"	58,7	20,3	40,4	Steel	151	SM-502-12FP
3/4"	3/4"	BSPP	1 1/2"	66	18,5	43,9	Steel	254	SM-752-12FB
3/4"	3/4" - 14	NPTF	1 1/2"	63	15	43,9	Steel	231	SM-752-12FP
3/4"	1"	BSPP	1 5/8"	68,3	22,1	47,8	Steel	308	SM-752-16FB
3/4"	1" - 11 1/2	NPTF	1 5/8"	68,3	22,1	47,8	Steel	278	SM-752-16FP

\* Exposed length. This dimension represents the portion that is exposed when the nipple is inserted into the mating Parker coupler.

## Dust Protection

## SM-Series

	Body Size	Version	Material	Part Number
	1/4"	for coupling	Rubber	PR-25
	1/2"	for coupling	Rubber	DP-50
	1/4"	for plug	Rubber	CR-25
	1/2"	for plug	Rubber	DC-50
	1/4"	for coupling	Aluminium	P-25
	1/2"	for coupling	Aluminium	P-50
	3/4"	for coupling	Aluminium	P-75
	1/4"	for plug	Aluminium	C-25
	1/2"	for plug	Aluminium	C-50
	3/4"	for plug	Aluminium	C-75

## Seal-Kit

## SM-Series

	Body Size	Version	Material	Part Number
	1/4"	Seal	NBR	020113N0674
	1/2"	Seal	NBR	020211N0674
	1/2"	Back-up ring	PTFE	50014-211
	3/4"	Seal	NBR	020219N0674
	3/4"	Back-up ring	PTFE	50014-219





**Technical Description**

Non-valved couplings. Maximal flow. Minimal pressure drop. Easy cleaning. This series is also manufactured as an alternative in steel and AISI 316 material.

**Advantages**

No valving allows minimal pressure drop, maximal flow and easy cleaning. The ball locking mechanism with high number of balls to distributes the work load assures low wearing and good alignment of the couplings. High resistance to brinelling due to heat treated nipples.

**Applications**

- Food industry
- High pressure water and steam washers
- Dye transfer lines
- Mold coolant lines
- Carpet cleaners

**Working Temperature**

-40°C up to +110°C (NBR) depending on the medium. Special seals are available on request (see page 6 ff).

**Sleeve-Lock**

ST series couplers can be furnished with locking sleeves. Place suffix letters **SL** (Sleeve-lock) after regular catalog numbers. Example: **SST-4M-SL**

**Working Pressure**

Body Size	Brass	Stainless Steel
1/8"	175 bar	290 bar
1/4"	360 bar	460 bar
3/8"	185 bar	380 bar
1/2"	150 bar	210 bar
3/4"	120 bar	210 bar
1"	80 bar	120 bar
1 1/4"	120 bar	
1 1/2"	95 bar	

Material Coupling	Brass	Stainless Steel
Coupling Body	Brass	AISI 303
Sleeve	Brass	AISI 303
Back-up Ring	AISI 303	AISI 303
Valve	AISI 303	AISI 303
Springs	NBR	NBR
Locking Balls	Brass	AISI 303

Material Plug	Brass	Stainless Steel
Plug Body	Brass	AISI 303

**Flow Capacity with Oil with Viscosity of 43cSt at 38°C as per ISO 7241/2-2000**

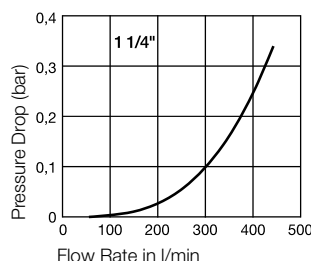
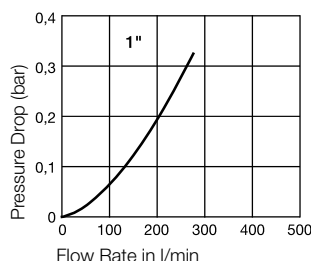
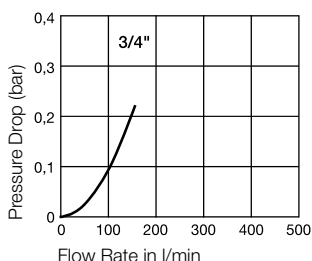
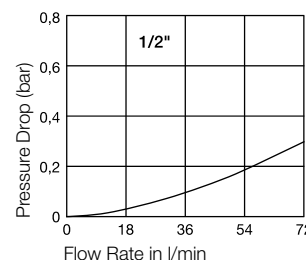
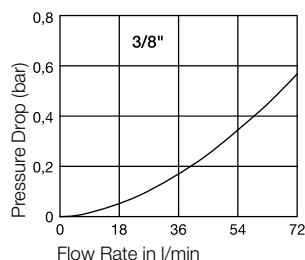
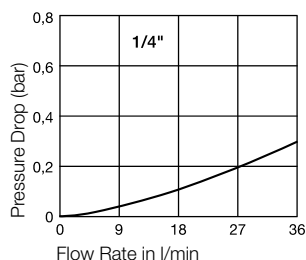
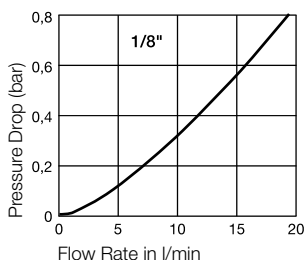

# Couplings

# ST-Series Brass

Body Size	Connection A	Thread	Hex	L mm	L1 mm	L2 mm	D mm	Bore mm	Version	Weight gr.	Part Number
1/8"	1/8" - 27	NPTF	9/16"	25,4			17,5	4,4	Brass	29	BST-1
1/4"	1/4"	BSPP	13/16"	39,1			23,8	6,4	Brass	85	BST-2-BSPP
1/4"	1/4" - 18	NPTF	13/16"	37,3			23,8	6,4	Brass	83	BST-2
3/8"	3/8"	BSPP	1"	41,7			29,0	9,5	Brass	122	BST-3-BSPP
3/8"	3/8" - 18	NPTF	1"	41,8			29,0	9,5	Brass	130	BST-3
1/2"	1/2"	BSPP	1 1/8"	50,3			33,3	11,9	Brass	186	BST-4-BSPP
1/2"	1/2"-14	NPTF	1 1/8"	48,5			33,3	11,9	Brass	189	BST-4
3/4"	3/4"	BSPP	1 7/16"	54,6			41,7	18,3	Brass	294	BST-6-BSPP
3/4"	3/4" - 14	NPTF	1 7/16"	52,1			41,7	18,3	Brass	316	BST-6
1"	1"	BSPP	1 3/4"	61,7			50,8	23,8	Brass	467	BST-8-BSPP
1"	1" - 11 1/2	NPTF	1 3/4"	58,7			50,8	23,8	Brass	477	BST-8
1 1/4"	1 1/4" -11 1/2	NPTF	2"	62,0			64,0	30,2	Brass	720	BST-10
1 1/2"	1 1/4"-11 1/2	NPTF	2 1/2"	72,9			76,2	38,1	Brass	1176	BST-12

1/8"	1/8" - 27	NPTF	9/16"	26,9	9,5		17,5	4,4	Brass	24	BST-1M
1/4"	1/4" - 18	NPTF	13/16"	42,9	13,5		23,8	6,4	Brass	92	BST-2M
3/8"	3/8" - 18	NPTF	1"	44,5	14,5		29,0	9,5	Brass	108	BST-3M
1/2"	1/2" - 14	NPTF	1 1/8"	50,5	19,1		33,3	11,9	Brass	152	BST-4M
3/4"	3/4" - 14	NPTF	1 7/16"	55,1	13,9		41,7	18,3	Brass	227	BST-6M
1"	1" - 11 1/2	NPTF	1 3/4"	64,3	25,4		50,8	23,8	Brass	402	BST-8M

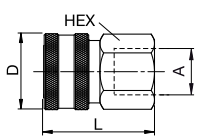

Female Thread

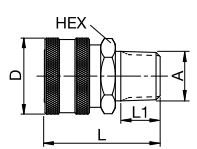

Male Thread

# Plugs

# ST-Series Brass

Body Size	Connection A	Thread	Hex	L mm	L1 mm	L2 mm	D mm	Bore mm	Version	Weight gr.	Part Number
1/8"	1/8" - 27	NPTF	9/16"	24,6	14,3		16,4	4,4	Brass	15	BST-N1
1/4"	1/4"	BSPP	3/4"	37,1	18,1		21,9	6,4	Brass	40	BST-N2-BSPP
1/4"	1/4" - 18	NPTF	3/4"	37,1	18,1		21,9	6,4	Brass	48	BST-N2
3/8"	3/8"	BSPP	7/8"	41,9	19,1		25,6	9,5	Brass	57	BST-N3-BSPP
3/8"	3/8" - 18	NPTF	7/8"	41,3	19,1		25,6	9,5	Brass	58	BST-N3
1/2"	1/2"	BSPP	1 1/8"	48,5	24,7		32,9	11,9	Brass	110	BST-N4-BSPP
1/2"	1/2" - 14	NPTF	1 1/8"	48,5	24,7		32,9	11,9	Brass	114	BST-N4
3/4"	3/4"	BSPP	1 3/8"	54,5	26,5		40,2	18,3	Brass	172	BST-N6-BSPP
3/4"	3/4" - 14	NPTF	1 3/8"	54,5	26,5		40,2	18,3	Brass	175	BST-N6
1"	1"	BSPP	1 5/8"	59,6	29,0		47,5	23,8	Brass	271	BST-N8-BSPP
1"	1" - 11 1/2	NPTF	1 5/8"	59,6	29,0		47,5	23,8	Brass	240	BST-N8
1 1/4"	1 1/4" -11 1/2	NPTF	2"	60,3	29,2		58,4	30,2	Brass	482	BST-N10
1 1/2"	1 1/4" -11 1/2	NPTF	2 3/8"	71,3	29,7		69,5	38,1	Brass	688	BST-N12

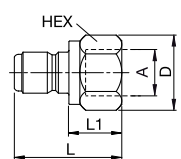

Female Thread

# Plugs

# ST-Series Brass

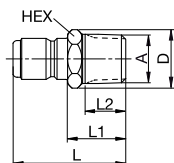

Male Thread

Body Size	Connection A	Thread	Hex	L mm	L1 mm	L2 mm	D mm	Bore mm	Version	Weight gr.	Part Number
1/8"	1/8"-27	NPTF	7/16"	26,3	15,9	9,5	12,8	4,4	Brass	11	BST-N1M
1/4"	1/4"-18	NPTF	9/16"	38,8	19,8	13,5	16,4	6,4	Brass	27	BST-N2M
1/4"	1/4"	BSPT	9/16"	38,8	19,8	8,4	16,4	6,4	Brass	31	BST-N2M-BSPT
3/8"	3/8"-18	NPTF	11/16"	42,9	20,7	14,5	20,1	9,5	Brass	40	BST-N3M
3/8"	3/8"	BSPT	11/16"	42,9	20,7	8,7	20,1	9,5	Brass	39	BST-N3M-BSPT
1/2"	1/2"-14	NPTF	7/8"	49,2	25,4	19,1	25,6	11,9	Brass	68	BST-N4M
1/2"	1/2"	BSPT	7/8"	49,2	25,4	11,3	25,6	11,9	Brass	67	BST-N4M-BSPT
3/4"	3/4"-14	NPTF	1 1/16"	55,7	27,8	13,9	31,0	18,3	Brass	107	BST-N6M
3/4"	3/4"	BSPT	1 1/16"	55,7	27,8	12,7	31,0	18,3	Brass	107	BST-N6M-BSPT
1"	1"-11 1/2	NPTF	1 3/8"	63,7	33,1	25,4	40,2	23,8	Brass	208	BST-N8M
1"	1"	BSPT	1 3/8"	63,7	33,1	14,4	40,2	23,8	Brass	238	BST-N8M-BSPT

# Couplings

# ST-Series Stainless Steel

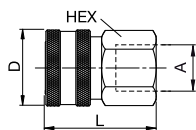

Female Thread

Body Size	Connection A	Thread	Hex	L mm	L1 mm	L2 mm	D mm	Bore mm	Version	Weight gr.	Part Number
1/8"	1/8"-27	NPTF	9/16"	25,4			17,5	4,4	AISI 303	23	SST-1
1/4"	1/4"	BSPP	13/16"	39,1			23,8	6,4	AISI 303	74	SST-2-BSPP
1/4"	1/4"-18	NPTF	13/16"	37,3			23,8	6,4	AISI 303	75	SST-2
3/8"	3/8"	BSPP	1"	41,7			29,0	9,5	AISI 303	115	SST-3-BSPP
3/8"	3/8"-18	NPTF	1"	40,4			29,0	9,5	AISI 303	117	SST-3
1/2"	1/2"	BSPP	1 1/8"	50,3			33,3	11,9	AISI 303	172	SST-4-BSPP
1/2"	1/2"-14	NPTF	1 1/8"	48,5			33,3	11,9	AISI 303	174	SST-4
3/4"	3/4"	BSPP	1 7/16"	54,6			41,7	18,3	AISI 303	268	SST-6-BSPP
3/4"	3/4"-14	NPTF	1 7/16"	52,1			41,7	18,3	AISI 303	304	SST-6
1"	1"-11 1/2	NPTF	1 3/4"	58,7			50,8	23,8	AISI 303	519	SST-8

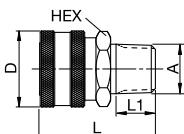

Male Thread

1/8"	1/8"-27	NPTF	9/16"	26,9	9,5		17,5	4,4	AISI 303	22	SST-1M
1/4"	1/4"-18	NPTF	13/16"	42,9	13,5		23,8	6,4	AISI 303	71	SST-2M
1/4"	1/4"-18	NPTF	13/16"	42,9	13,5		23,8	6,4	AISI 303	71	SST-2M
1/2"	1/2"-14	NPTF	1 1/8"	50,5	19,1		33,3	11,9	AISI 303	149	SST-4M
3/4"	3/4"-14	NPTF	1 7/16"	55,1	13,9		41,7	18,3	AISI 303	211	SST-6M
1"	1"-11 1/2	NPTF	1 3/4"	64,3	25,4		50,8	23,8	AISI 303	385	SST-8M



# Plugs

# ST-Series Stainless Steel

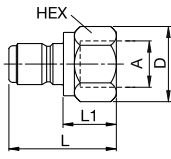
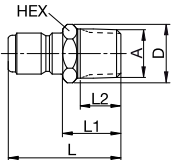
	Body Size	Connection A	Thread	Hex	L mm	L1 mm	L2 mm	D mm	Bore mm	Version	Weight gr.	Part Number
 <p>Female Thread</p>	1/8"	1/8"-27	NPTF	9/16"	24,8	14,3		16,4	4,4	AISI 303	17	SST-N1
	1/4"	1/4"	BSPP	3/4"	37,1	18,1		21,9	6,4	AISI 303	36	SST-N2-BSPP
	1/4"	1/4"-18	NPTF	3/4"	37,1	18,1		21,9	6,4	AISI 303	36	SST-N2
	3/8"	3/8"	BSPP	7/8"	41,3	19,1		25,6	9,5	AISI 303	53	SST-N3-BSPP
	3/8"	3/8"-18	NPTF	7/8"	41,3	19,1		25,6	9,5	AISI 303	50	SST-N3
	1/2"	1/2"	BSPP	1 1/8"	48,5	24,7		32,9	11,9	AISI 303	103	SST-N4-BSPP
	1/2"	1/2"-14	NPTF	1 1/8"	48,5	24,7		32,7	11,9	AISI 303	105	SST-N4
	3/4"	3/4"	BSPP	1 3/8"	54,5	26,5		40,2	18,3	AISI 303	156	SST-N6-BSPP
	3/4"	3/4"-14	NPTF	1 3/8"	54,5	26,5		40,2	18,3	AISI 303	169	SST-N6
	1"	1"-11 1/2	NPTF	1 5/8"	59,6	29,0		47,5	23,8	AISI 303	272	SST-N8
 <p>Male Thread</p>	1/8"	1/8"-27	NPTF	7/16"	26,3	15,9	9,5	12,8	4,4	AISI 303	10	SST-N1M
	1/4"	1/4"-18	NPTF	9/16"	38,8	19,8	13,5	16,4	6,4	AISI 303	24	SST-N2M
	3/8"	3/8"-18	NPTF	11/16"	42,9	20,7	14,5	20,1	9,5	AISI 303	41	SST-N3M
	1/2"	1/2"-14	NPTF	7/8"	49,2	25,4	19,1	25,6	11,9	AISI 303	64	SST-N4M
	3/4"	3/4"-14	NPTF	1 1/16"	55,7	27,8	13,9	31,0	18,3	AISI 303	100	SST-N6M
	1"	1"-11 1/2	NPTF	1 3/8"	63,7	33,1	25,4	40,2	23,8	AISI 303	198	SST-N8M

# Seal-Kit

# ST-Series

	Body Size	Version	Material	Part Number
	1/8"	Seal	NBR	020010N0674
	1/4"	Seal	NBR	020110N0674
	3/8"	Seal	NBR	020112N0674
	1/2"	Seal	NBR	020114N0674
	3/4"	Seal	NBR	020212N0674
	1"	Seal	NBR	020217N0674
	1 1/4"	Seal	NBR	020222N0674
	1 1/2"	Seal	NBR	020327N0674



Body Size

3/8" up to 1"

Parker Profile

NS-Series



**Technical Description**

The NS series is unique among non spill types in having a recess on the female side to help locate the male during connection, making the process easy even in „blind“ conditions. Minimal fluid loss during disconnection. NS couplings have minimal pressure drop and minimal inclusion of air or dust during connection.

**Advantages**

Push to connect system: Push on the male tip to connect. Flush-faced poppet valve for reduced spillage during connection/disconnection. The seal is crimped to prevent seal washout at high flow rates. Solid steel barstock construction: induction-hardened for a quality coupling with maximum resistance to damage from hydraulic and mechanical shock and brinelling. A safety sleeve lock prevents accidental disconnection. Sleeve is rotated to the stop to engage the lock.

**Applications**

- Maintenance of high-voltage power transmission lines
- Construction, railway maintenance and mining industry
- Inplant use where oil spillage can create a hazard
- Overhead bucket hoists

**Working Temperature**

-40°C up to + 110°C (NBR) depending on the medium. Special seals are available on request (see page 6 ff).

**Working Pressure**

Body Size	Max. Operating Pressure connected
3/8"	175 bar
1/2"	175 bar
3/4"	175 bar
1"	175 bar

**Spillage and Air Inclusion**

Body Size	Spillage max. per disconnection	Air inclusion max. per disconnection
3/8"	0,020 ml	0,010 ml
1/2"	0,070 ml	0,020 ml
3/4"	0,150 ml	0,050 ml
1"	0,220 ml	0,070 ml

Material Coupling	Standard
Coupling Body	Steel
Sleeve	Steel
Back-up Ring	PTFE
Valve	Steel
Springs	Steel
Locking Balls	Stainless Steel
Seals	NBR
Material Plug	Standard
Plug Body	Steel
Valve	Steel
Springs	Steel
Seals	NBR
Valve Holder	Aluminium

**Flow Capacity with Oil with Viscosity of 43cSt at 38°C as per ISO 7241/2-2000**

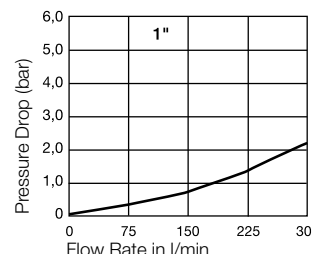
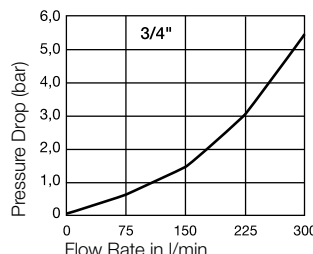
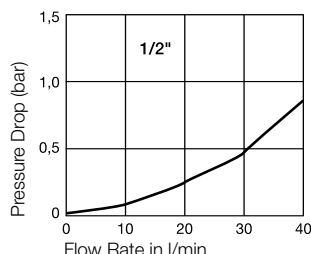
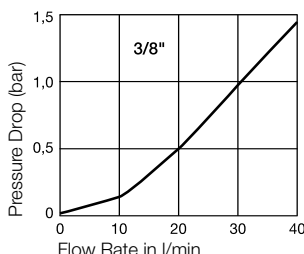

## Couplings

## NS-Series

Body Size	Connection A	Thread	Hex	L mm	L1 mm	D mm	Version	Weight gr.	Part Number
3/8"	3/8"	BSPP	1 1/16"	53,3		28,7	Steel	164	NS-371-6FB
3/8"	3/8" - 18	NPSF	1 1/16"	53,3		28,7	Steel	174	NS-371-6FP
1/2"	1/2"	BSPP	1 1/4"	75,4		39,2	Steel	373	NS-501-8FB
1/2"	1/2" - 14	NPSF	1 1/4"	73,2		39,2	Steel	389	NS-501-8FP
3/4"	3/4"	BSPP	1 9/16"	85,3		49,8	Steel	711	NS-751-12FB
3/4"	3/4" - 14	NPSF	1 9/16"	81		49,8	Steel	694	NS-751-12FP
1"	1"	BSPP	1 3/4"	96,8		57,2	Steel	775	NS-1001-16FB
1"	1" - 11 1/2	NPSF	1 3/4"	94		57,2	Steel	1065	NS-1001-16FP

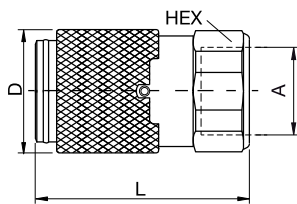

Female Thread\*

## Plugs

## NS-Series

Body Size	Connection A	Thread	Hex	L mm	L1 mm	D mm	Version	Weight gr.	Part Number
3/8"	3/8"	BSPP	15/16"	31,8	45,2	27,4	Steel	70	NS-372-6FB
3/8"	3/8" - 18	NPSF	15/16"	29,7	43,2	27,4	Steel	73	NS-372-6FP
1/2"	1/2"	BSPP	1 1/16"	21,1	49,5	31,2	Steel	106	NS-502-8FB
1/2"	1/2" - 14	NPSF	1 1/16"	17,5	46	31,2	Steel	96	NS-502-8FP
3/4"	3/4"	BSPP	1 3/8"	34	62,7	40,4	Steel	233	NS-752-12FB
3/4"	3/4" - 14	NPSF	1 3/8"	28,4	57,2	40,4	Steel	237	NS-752-12FP
1"	1"	BSPP	1 5/8"	42,7	70,6	47,8	Steel	355	NS-1002-16FB
1"	1" - 11 1/2	NPSF	1 5/8"	39,1	67,1	47,8	Steel	326	NS-1002-16FP

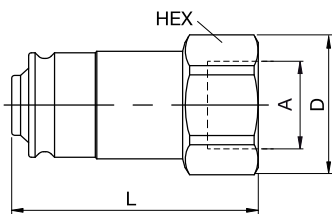

Female Thread\*

\*NPSF threads in this series are straight (cylindrical) instead of tapered. These threads are primarily intended for assembly with full length NPTF external taper threads.

## Dust Protection

## NS-Series

Body Size	Version	Material	Part Number
3/8"	for coupling and plug	Thermoplastic	NR-37
1/2"	for coupling and plug	Thermoplastic	NR-50
3/4"	for coupling and plug	Thermoplastic	NR-75
1"	for coupling and plug	Thermoplastic	NR-100





Body Size

3/8" up to 1"

Screw-to-Connect

QHPA-Series

**Technical Description**

Screw to connect type of coupling for difficult applications. Rugged, modular construction in steel, working up to 450 bar.

**Advantages**

Self locking threads and external seal to prevent accidental disconnection. NBR seals and back-up ring in PTFE to withstand pressure impulses. Sleeve mounted on the male tip to protect the sealing area.

Three-part poppet style valving with a molded shaped seal to prevent seal washout at high flow rates.

**Applications**

- Agricultural and mobile equipment
- Rock hammers
- Forestry equipments
- Snow groomers
- Excavators

**Working Pressure**

3/8"	450 bar
1/2"	400 bar
3/4"	315 bar
1"	200 bar

For the DIN 2353 light series with metric threads the maximum operating pressure is 315 bar up to 18L and 160 bar for 22L.

**Working Temperature**

-25°C up to +110°C (NBR) depending on the medium.

Material Coupling	Standard
Valve Body	Steel, silver plated
Back Body	Steel, silver plated
Back-up Ring	PTFE
Valve	Steel, silver plated
Springs	Steel
Seals	NBR
Valve Holder	Steel
Material Plug	Standard
Plug Body	Steel, silver plated
Valve	Steel, silver plated
Springs	Steel
Seals	NBR
Valve Holder	Steel, silver plated
Sleeve	Steel, silver plated

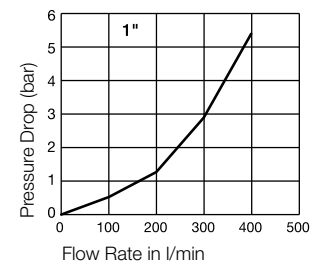
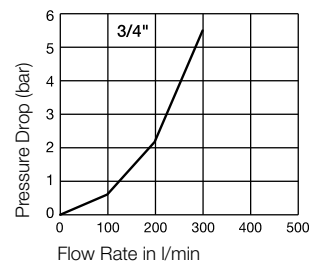
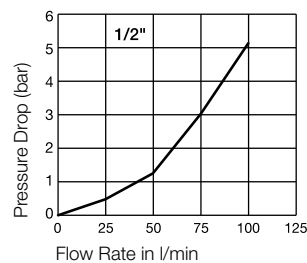
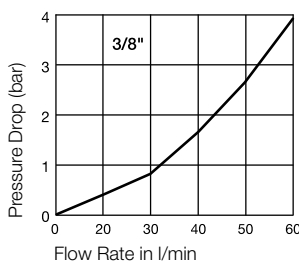
**Flow Capacity with Oil with Viscosity of 43cSt at 38°C as per ISO 7241/2-2000**

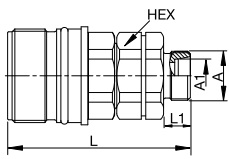
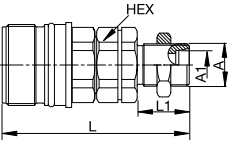
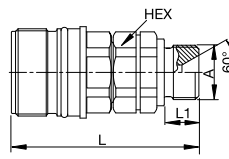
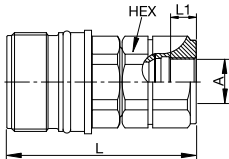
	Size	Body Size	Conne- ction A	Tube O/D A1	Hex mm	Hex1 mm	L mm	L1 mm	D1 mm	Version	Weight gr.	Part Number
 <p>Male Thread 24° cone – DIN 2353</p>	2	3/8"	M 14 x 1,5	8	22		62	10		Light Series	147	QHPA53D6X2-B
	2	3/8"	M 16 x 1,5	10	22		63	11		Light Series	148	QHPA53D6X3-B
	2	3/8"	M 18 x 1,5	10	22		64	12		Heavy Series	154	QHPA53D7X3-B
	2	3/8"	M 20 x 1,6	12	22		64	12		Heavy Series	156	QHPA53D7X4-B
	3	1/2"	M 18 x 1,5	12	30		65	11		Light Series	285	QHPA54D6X4-B
	3	1/2"	M 22 x 1,5	15	30		66	12		Light Series	290	QHPA54D6X5-B
	3	1/2"	M 22 x 1,6	14	30		68	14		Heavy Series	277	QHPA54D7X5-B
	3	1/2"	M 24 x 1,5	16	30		68	14		Heavy Series	298	QHPA54D7X6-B
	6	3/4"	M 26 x 1,5	18	41		93	12		Light Series	729	QHPA56D6X6-B
	6	3/4"	M 30 x 2	22	41		95	14		Light Series	736	QHPA56D6X7-B
	6	3/4"	M 30 x 2	20	41		97	16		Heavy Series	747	QHPA56D7X7-B
	6	3/4"	M 36 x 2	25	41		99	18		Heavy Series	765	QHPA56D7X8-B
8	1"	M 42 x 2	30	55		122	20		Heavy Series	1572	QHPA58D7X9-B	
 <p>Male Thread 24° cone – DIN 2353 Bulkhead</p>	2	3/8"	M 14 x 1,5	8	22		78	26		Light Series	167	QHPA53E6X2-B
	2	3/8"	M 16 x 1,5	10	22		78	26		Light Series	179	QHPA53E6X3-B
	2	3/8"	M 18 x 1,5	10	22		79	27		Heavy Series	188	QHPA53E7X3-B
	2	3/8"	M 20 x 1,5	12	22		79	27		Heavy Series	198	QHPA53E7X4-B
	3	1/2"	M 18 x 1,5	12	30		80	26		Light Series	313	QHPA54E6X4-B
	3	1/2"	M 22 x 1,5	15	30		81	27		Light Series	337	QHPA54E6X5-B
	3	1/2"	M 24 x 1,5	16	30		83	29		Heavy Series	356	QHPA54E7X6-B
	6	3/4"	M 26 x 1,5	18	41		115	27		Light Series	822	QHPA56E6X6-B
	6	3/4"	M 30 x 2	20	41		117	27		Heavy Series	865	QHPA56E7X7-B
	6	3/4"	M 36 x 2	25	41		119	27		Heavy Series	918	QHPA56E7X8-B
8	1"	M 42 x 2	30	55		142	40		Heavy Series	1757	QHPA58E7X9-B	
 <p>Male BSPP Thread – DIN 3852 Form B</p>	2	3/8"	3/8"		22		66	12			183	QHPA53F4B3-B
	3	1/2"	1/2"		30		71	14			301	QHPA54F4B4-B
 <p>Female BSPP Thread – DIN 3852 Form Y</p>	2	3/8"	3/8"		22		64	12			155	QHPA53G4X3-B
	3	1/2"	1/2"		30		67	12			311	QHPA54G4X4-B
	6	3/4"	3/4"		41		100	16,5			838	QHPA56G4X6-B
	6	3/4"	1"		41		100	18			786	QHPA56G4X8-B

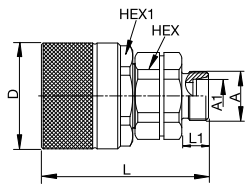
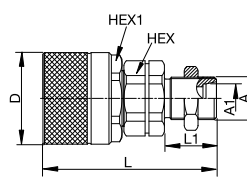
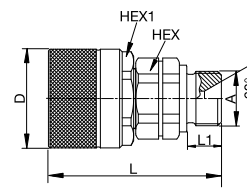
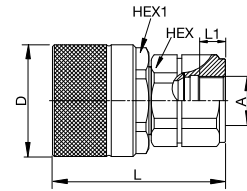

# Plugs

# QHPA-Series

	Size	Body Size	Connec-tion A	Tube O/D A1	Hex mm	Hex1 mm	L mm	L1 mm	D1 mm	Version	Weight gr.	Part Number
 <p>Male Thread 24° cone – DIN 2353</p>	2	3/8"	M 14 x 1,5	8	22	30	59	10	34	Light Series	153	QHPA13D6X2-B
	2	3/8"	M 16 x 1,5	10	22	30	60	11	34	Light Series	154	QHPA13D6X3-B
	2	3/8"	M 18 x 1,5	10	22	30	61	12	34	Heavy Series	160	QHPA13D7X3-B
	2	3/8"	M 20 x 1,6	12	22	30	61	12	34	Heavy Series	162	QHPA13D7X4-B
	3	1/2"	M 18 x 1,5	12	30	36	62	11	42	Light Series	242	QHPA14D6X4-B
	3	1/2"	M 22 x 1,5	15	30	36	63	12	42	Light Series	247	QHPA14D6X5-B
	3	1/2"	M 22 x 1,6	14	30	36	65	14	42	Heavy Series	254	QHPA14D7X5-B
	3	1/2"	M 24 x 1,5	16	30	36	65	14	42	Heavy Series	255	QHPA14D7X6-B
	6	3/4"	M 26 x 1,5	18	41	50	80	12	55	Light Series	656	QHPA16D6X6-B
	6	3/4"	M 30 x 2	22	41	50	82	14	55	Light Series	663	QHPA16D6X7-B
	6	3/4"	M 30 x 2	20	41	50	84	16	55	Heavy Series	674	QHPA16D7X7-B
	6	3/4"	M 36 x 2	25	41	50	86	18	55	Heavy Series	592	QHPA16D7X8-B
8	1"	M 42 x 2	30	55	80	117	20	85	Heavy Series	2082	QHPA18D7X9-B	
 <p>Male Thread 24° cone – DIN 2353 Bulkhead</p>	2	3/8"	M 14 x 1,5	8	22	30	75	26	34	Light Series	173	QHPA13E6X2-B
	2	3/8"	M 16 x 1,5	10	22	30	75	26	34	Light Series	173	QHPA13E6X3-B
	2	3/8"	M 18 x 1,5	10	22	30	76	27	34	Heavy Series	194	QHPA13E7X3-B
	2	3/8"	M 20 x 1,5	12	22	30	76	27	34	Heavy Series	204	QHPA13E7X4-B
	3	1/2"	M 18 x 1,5	12	30	36	77	26	42	Light Series	270	QHPA14E6X4-B
	3	1/2"	M 22 x 1,5	15	30	36	78	27	42	Light Series	294	QHPA14E6X5-B
	3	1/2"	M 24 x 1,5	16	30	36	80	29	42	Heavy Series	313	QHPA14E7X6-B
	6	3/4"	M 26 x 1,5	18	41	50	102	27	55	Light Series	749	QHPA16E6X6-B
	6	3/4"	M 30 x 2	20	41	50	104	27	55	Heavy Series	792	QHPA16E7X7-B
	6	3/4"	M 36 x 2	25	41	50	106	27	55	Heavy Series	845	QHPA16E7X8-B
	8	1"	M 42 x 2	30	55	80	137	40	85	Heavy Series	2350	QHPA18E7X9-B
	 <p>Male BSPP Thread – DIN 3852 Form B</p>	2	3/8"	3/8"		22	30	62	12	34		188
3		1/2"	1/2"		30	36	68	14	42		258	QHPA14F4B4-B
 <p>Female BSPP Thread – DIN 3852 Form Y</p>	2	3/8"	3/8"		22	30	61	12	34		161	QHPA13G4X3-B
	3	1/2"	1/2"		30	36	64	12	42		268	QHPA14G4X4-B
	6	3/4"	3/4"		41	50	87	16,5	55		765	QHPA16G4X6-B
	6	3/4"	1"		41	50	87	18	55		713	QHPA16G4X8-B

## Dust Protection

## QHPA-Series

	Body Size	Description	Material	Color	Part Number
	3/8"	for coupling	Plastic	Red	QHPA13-DC
	1/2"	for coupling	Plastic	Red	QHPA14-DC
	3/4"	for coupling	Plastic	Red	QHPA16-DC
	1"	for coupling	Plastic	Red	QHPA18-DC
	3/8"	for plug	Plastic	Red	QHPA53-DP
	1/2"	for plug	Plastic	Red	QHPA54-DP
	3/4"	for plug	Plastic	Red	QHPA56-DP
	1"	for plug	Plastic	Red	QHPA58-DP

## Seal-Kit

## QHPA-Series

	Body Size	Description	Part Number
	3/8"	NBR/PTFE	QHPA53-KIT
	1/2"	NBR/PTFE	QHPA54-KIT
	3/4"	NBR/PTFE	QHPA56-KIT
	1"	NBR/PTFE	QHPA58-KIT
<p>O-Ring NBR and Back-up Ring PTFE</p> <p>The Kit contains the O-Ring and the outside ring in NBR as well as the back-up ring in PTFE.</p>			



Body Size

3/4" up to 1 1/2"

Parker Profile

6100-Series

**Technical Description**

Screw-to-connect coupling. Connection and disconnection possible with full system pressure. Compatible with a broad range of media. Limited fluid spillage during disconnection.

**Advantages**

Bonded valve seal permits full pressure connect and disconnect without seal washout. Heavy-duty wing nut, ruggedly built, specifically to withstand the hammer blows, used to tighten and loosen this coupler. Flush-faced poppet valve

for reduced spillage during disconnection. Connection indicator: visual check for complete connection of the couplings.

The flange is designed to give a positive "no-slip" bulkhead mounting to reduce downtime.

**Applications**

- Dump trailers: to connect the tractor to wet-line hydraulic systems
- Connection of hydraulic lines on oil field equipment like power tongs, swivels and mobile drilling rings.
- Submersible pumps, engine test stands
- Applications where heavy-duty couplings are required

**Working Temperature**

-40°C up to + 110°C (NBR) depending on the medium.

**Working pressure**

Body Size	Max. operating pressure connected
3/4"	210 bar
1"	210 bar
1 1/4"	190 bar
1 1/2"	175 bar

Material Coupling	Standard
Coupling Body	Brass
Sleeve	Steel
Back-up Ring	PTFE
Valve	Brass
Springs	Stainless Steel
Seals	NBR

Material Plug	Standard
Plug Body	Brass
Valve	Brass
Springs	Stainless Steel
Seals	NBR

**Flow Capacity with Oil with Viscosity of 43cSt at 38°C as per ISO 7241/2-2000**

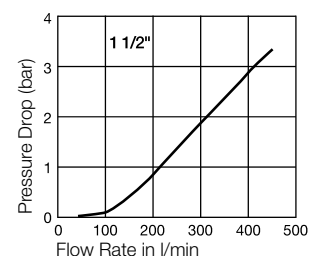
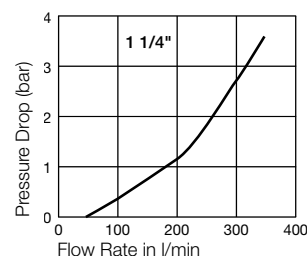
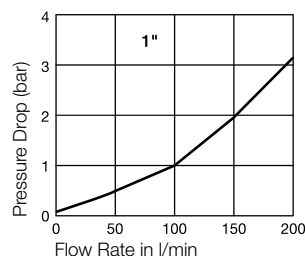
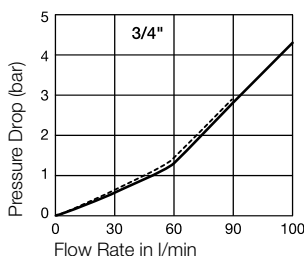
— Female thread 1/2" - 14  
 ..... Female thread 3/4" - 18



## Couplings with wing nut

## 6100-Series

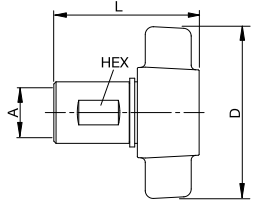

Body Size	Connection A	Thread	Hex	Hex1	D mm	L mm	Weight gr.	Part Number
3/4"	1/2"	BSPP	1 5/32"		102,6	75,9	600	6125-08-BSPP
3/4"	3/4"	BSPP	1 5/32"		102,6	79,8	560	6125-12-BSPP
3/4"	1/2" - 14	NPTF	1 5/32"		102,6	75,9	590	6125-08
3/4"	3/4" - 14	NPTF	1 5/32"		102,6	79,8	572	6125-12
1"	1"	BSPP	1 7/16"		111,3	96,5	869	6125-16-BSPP
1"	1" - 11 1/2	NPTF	1 7/16"		111,3	96,5	857	6125-16
1 1/4"	1 1/4"	BSPP	1 25/32"		132,1	103,8	1221	6125-20-BSPP
1 1/4"	1 1/4" - 11 1/2	NPTF	1 25/32"		132,1	103,8	1288	6125-20
1 1/2"	1 1/2"	BSPP	2"		135,1	108,5	1733	6125-24-BSPP
1 1/2"	1 1/2" - 11 1/2	NPTF	2"		135,1	108,5	1687	6125-24

## Couplings with hexagon nut

## 6100-Series

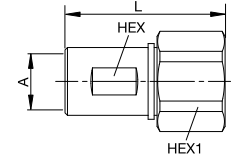

Body Size	Connection A	Thread	Hex	Hex1	D mm	L mm	Weight gr.	Part Number
3/4"	1/2" - 14	NPTF	1 5/32"	1 3/4"		81,8	485	6135-08
3/4"	3/4" - 14	NPTF	1 5/32"	1 3/4"		81,8	485	6135-12
1"	1" - 11 1/2	NPTF	1 7/16"	2 1/8"		98,3	739	6135-16
1 1/4"	1 1/4" - 11 1/2	NPTF	1 25/32"	2 1/2"		105,6	1120	6135-20

## Plugs

## 6100-Series

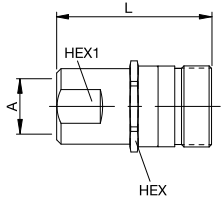
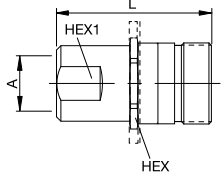

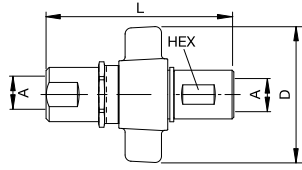

Body Size	Connection A	Thread	Hex	Hex1	D mm	L mm	Weight gr.	Part Number
3/4"	1/2"	BSPP	1 5/8"	1 3/16"		79	416	6105-08-BSPP
3/4"	3/4"	BSPP	1 5/8"	1 3/16"		83,8	349	6105-12-BSPP
3/4"	1/2" - 14	NPTF	1 5/8"	1 3/16"		79	374	6105-08
3/4"	3/4" - 14	NPTF	1 5/8"	1 3/16"		82	358	6105-12
1"	1"	BSPP	1 7/8"	1 9/16"		90,2	571	6105-16-BSPP
1"	1" - 11 1/2	NPTF	1 7/8"	1 9/16"		90,2	589	6105-16
1 1/4"	1 1/4"	BSPP	2 1/8"	1 7/8"		94,2	754	6105-20-BSPP
1 1/4"	1 1/4" - 11 1/2	NPTF	2 1/8"	1 7/8"		94,2	741	6105-20
1 1/2"	1 1/2"	BSPP	2 1/2"	2 3/16"		104,6	1155	6105-24-BSPP
1 1/2"	1 1/2" - 11 1/2	NPTF	2 1/2"	2 3/16"		104,6	988	6105-24
3/4"	1/2" - 14	NPTF	1 5/8"	1 3/16"		79	374	6115-08
3/4"	3/4" - 14	NPTF	1 5/8"	1 3/16"		82	358	6115-12
1"	1" - 11 1/2	NPTF	1 7/8"	1 9/16"		90,2	589	6115-16
1 1/4"	1 1/4" - 11 1/2	NPTF	2 1/8"	1 7/8"		94,2	741	6115-20
1 1/2"	1 1/2" - 11 1/2	NPTF	2 1/2"	2 3/16"		104,6	988	6115-24

**Complete Set with wing nut (Male + Female)****6100-Series**

Female Thread

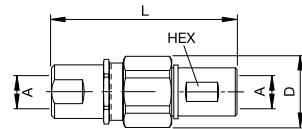
Body Size	Connection A	Thread	Hex	Hex1	D mm	L mm	Weight gr.	Part Number
3/4"	1/2" - 14	NPTF	1 5/32"		102,6	132,1		6100-08
3/4"	3/4" - 14	NPTF	1 5/32"		102,6	132,1		6100-12
1"	1" - 11 1/2	NPTF	1 7/16"		111,3	152,1		6100-16
1 1/4"	1 1/4" - 11 1/2	NPTF	1 25/32"		132,1	160,8		6100-20
1 1/2"	1 1/2" - 11 1/2	NPTF	2"		135,1	166,4		6100-24

**Complete Set with hexagon nut (Male + Female)****6100-Series**

Female Thread

Body Size	Connection A	Thread	Hex	Hex1	D mm	L mm	Weight gr.	Part Number
3/4"	1/2" - 14	NPTF	1 5/32"		102,6	132,1		6120-08
3/4"	3/4" - 14	NPTF	1 5/32"		102,6	132,1		6120-12
1"	1" - 11 1/2	NPTF	1 7/16"		111,3	152,1		6120-16
1 1/4"	1 1/4" - 11 1/2	NPTF	1 25/32"		132,1	160,8		6120-20
1 1/2"	1 1/2" - 11 1/2	NPTF	2"		135,1	166,4		6120-24

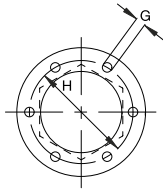
**Flange****6100-Series**

Body Size	G mm	H mm	Part Number
3/4"	5,3	54,0	6107-08
1"	5,3	60,3	6107-16
1 1/4"	5,3	66,7	6107-20
2 1/2"	7,1	82,6	6107-24

**Dust Protection****6100-Series**

Body Size	Version	Part Number
3/4"	for coupling	6109-08
1"	for coupling	6109-16
1 1/4"	for coupling	6109-20
1 1/2"	for coupling	6109-24
3/4"	for plug	6108-08
1"	for plug	6108-16
1 1/4"	for plug	6108-20
1 1/2"	for plug	6108-24





Body Size

1/2"

Multi-Couplings

# MACH-Series



### Technical Performance Data

Body Size inch	Temperatur Range	Maximum operating pressure
1/2"	-30°C up to +110°C	250 bar

### Top Connector (Coupling Plate)

This top connector unit includes the top casting and automatic protective cover, 4 to 7 female quick couplings and a complete locking system. In the most common version with 7 lines, the top connector is also equipped with a 6 line male electrical connector as a standard feature.

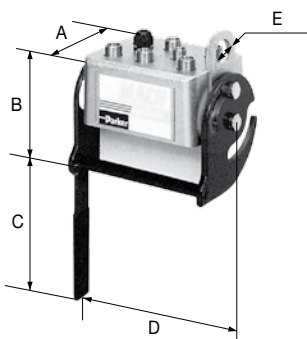

	1/2"
A	120 mm
B	145 mm
C	160 mm
D	210 mm
E	∅ 30 mm

### Base Connector (Plug Plate)

This base connector unit includes the base casting and automatic protective cover, 4 to 7 male quick couplings and the positioning pins. Also included are an adaptor and a plastic hose to drain oil. In the most common version with 7 lines, the base connector is also equipped with a 6 line male electrical connector as a standard feature.

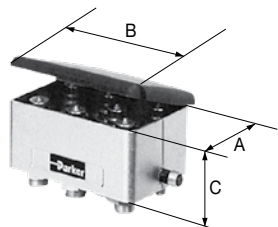

	1/2"
A	109 mm
B	170 mm
C	70 mm

### Technical Description

The couplings meet the requirements of ISO 7241-1 Series A. Possible to connect 4, 5, 6 or 7 hydraulic lines simultaneously. No coupling misconnection or accidental disconnection. Using a standard interface will still allow end users to connect their standard quick coupling equipped implements. In the version with seven lines (MACH 7), the base connector is equipped with an electrical connector as standard feature, which is an option on the MACH 4, 5 and 6.

### Advantages

Individual ball locking system and central cam locking mechanism: a simple movement enables to connect all the hydraulic lines. Three part poppet style valving with a molded shaped seal to prevent seal washout at high flow rates. Possible to connect with two lines under 200 bar, if other lines are not under pressure. Easy and fast connection and disconnection of implements or tooling.

### Applications

- Agricultural (front loaders, hedge cutters,...)
- Road service vehicles (road systems lorries, road sweepers, snowploughs,...)
- Industrial Applications

### Working Pressure

max. 250 bar

### Working Temperature

-30°C up to +110°C (NBR) depending on the medium.

### Flow Capacity with Oil with Viscosity of 43cSt at 38°C as per ISO 7241/2-2000

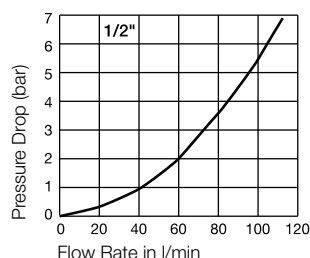

### Material

Coupling-/Plug plates	Steel
Support plate	Steel
Protective cap	Thermoplastic
Couplings and Plugs	Steel
Seals	NBR
Locking Mechanism	Steel
Connector Castings	Aluminium

### Installation

Base unit: Mounted with 4 screws M 8 x 1,25 mm

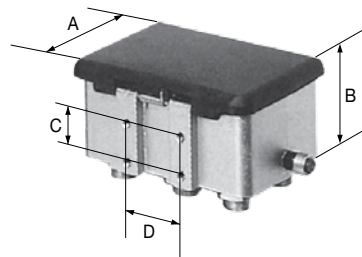

	1/2"
A	125 mm
B	80 mm
C	30 mm
D	50 mm

## Coupling Plate

## MACH-Series

	Body Size	Number of Hydraulic Lines	Number of Threads DIN2353 15L (M22x1,5)	Number of Threads DIN2353 12L (M18x1,5)	Electrical Connector	Part Number
	1/2"	4	4	0	without	MACH4/715LT
	1/2"	4	4	0	with	MACH4/715LTE
	1/2"	5	5	0	without	MACH5/715LT
	1/2"	5	5	0	with	MACH5/715LTE
	1/2"	6	6	0	without	MACH6/715LT
	1/2"	6	6	0	with	MACH6/715LTE
	1/2"	7	6	1	with	MACH7T

## Plug Plate

## MACH-Series

	Body Size	Number of Hydraulic Lines	Number of Threads DIN2353 15L (M22x1,5)	Number of Threads DIN2353 12L (M18x1,5)	Electrical Connector	Part Number
	1/2"	4	4	0	without	MACH4/715LB
	1/2"	4	4	0	with	MACH4/715LBE
	1/2"	5	5	0	without	MACH5/715LB
	1/2"	5	5	0	with	MACH5/715LBE
	1/2"	6	6	0	without	MACH6/715LB
	1/2"	6	6	0	with	MACH6/715LBE
	1/2"	7	6	1	with	MACH7B

## Oil Drain Kit

	Description	Part Number
	This kit includes the removable tank to contain oil spillage and a holding fixture.	MACH A

# Spare Parts

# MACH-Series

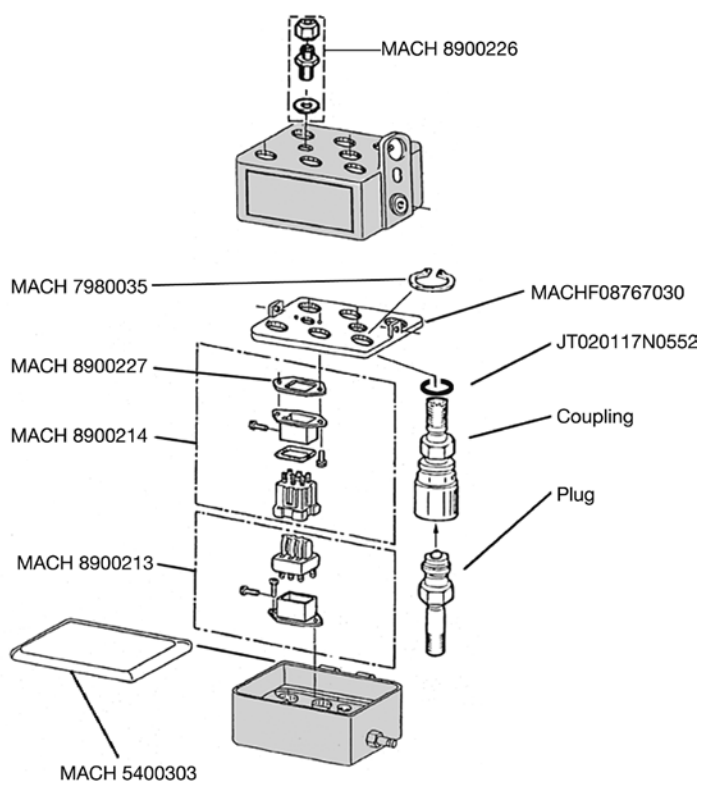

Description	End Configuration	Part Number
Electrical socket		MACH 8900214
Washer		MACH 8900227
Grommet		MACH 8900226
Electrical plug		MACH 8900213
Snap ring		MACH7980035
Counter plate		MACHF08767030
Cover		MACH5400303
Adaptor outside seal		JT020117N0552
Coupling	DIN 2353-15L	3V54D6X5MCH
Plug	DIN 2353-15L	4V14E6X5MCHA
Coupling	DIN 2353-12L	3V54D6X4MCH
Plug	DIN 2353-12L	4V14E6X4MCHA



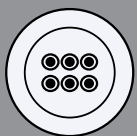

Body Size

1/2"

Multi-Couplings

# MACH 2-Series



### Technical Performance Data

Body Size inch	Temperatur Range	Maximum operating pressure
1/2"	-30°C up to +110°C	250 bar

### Connecting box (Coupling Plate)

Complete unit including the base connector unit, its dust cover, a lever acting as a central locking device and 2 female couplings.

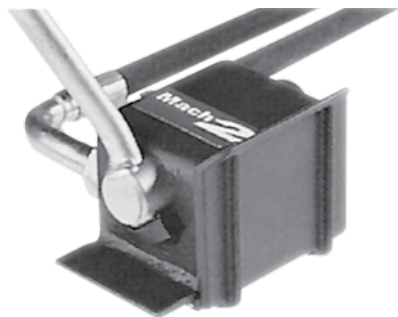

### Plug Plate

Complete unit including the connecting plug and 2 male tips, which meet the requirements of ISO 7241-1-A.

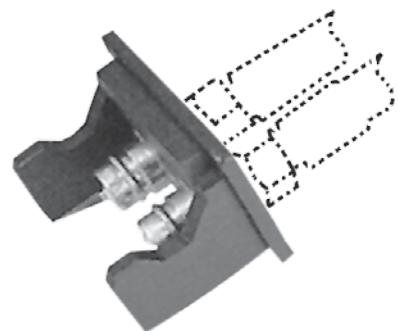

### Technical Description

The couplings meet requirements of ISO 7241-1 Series A. Possibility to connect 2 hydraulic lines simultaneously. No coupling misconnection or accidental disconnection. Possibility of connecting under pressure up to 250 bar in one hydraulic line only.

### Advantages

Central came locking system. Poppet style valving with a molded shaped seal to prevent seal washout at high flow rates.

### Applications

- Agricultural (front loaders, hedge cutters,...)
- Road service vehicles (road systems lorries, road sweepers, snowploughs,...)
- Industrial Applications

### Working Pressure

max. 250 bar

### Working Temperature

-30°C up to +110°C (NBR) depending on the medium.

### Flow Capacity with Oil with Viscosity of 43cSt at 38°C as per ISO 7241/2-2000

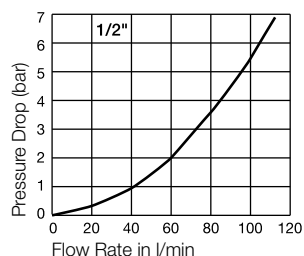

### Material

Protective cap	Thermoplastic
Quick Connect Couplings/-Plugs	Steel
Seals	NBR
Locking Mechanism	Steel
Casting boxes	Steel

### Installation

Mechanical attachment: 2 mounting holes  $\varnothing$  8,5 mm

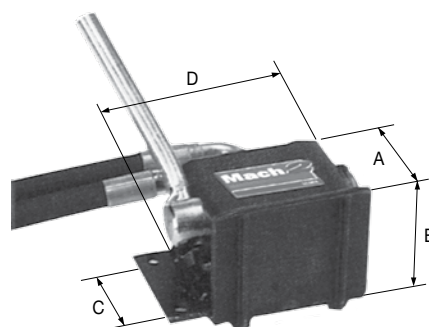

1/2"	
A	100 mm
B	80 mm
C	55 mm
D	125 mm



## Coupling Plate

## MACH 2-Series

End Configuration	Coupling (2 pcs.)	Top Casting (1 pc.)	Weight gr.	Part Number
M 22 x 1,5 - DIN2353-15L	1/2"	1/2"	2723	MACH2-IA-B
Other types of MACH 2 with non-spill connections are also available on request. Please consult us for further information.				

## Plug Plate

## MACH 2-Series

End Configuration	Coupling (2 pcs.)	Top Casting (1 pc.)	Weight gr.	Part Number
M 22 x 1,5 - DIN2353-15L	1/2"	1/2"	1203	MACH2-IA-P

## Spare Parts

Description	Part Number
Coupling seal	JT020117N0552
Coupling	LV54D6X5MLXC
Plug	LV14E6X5MLX



Body Size

3/8" up to 1/2"

Multi-Line

## C-Line Compact

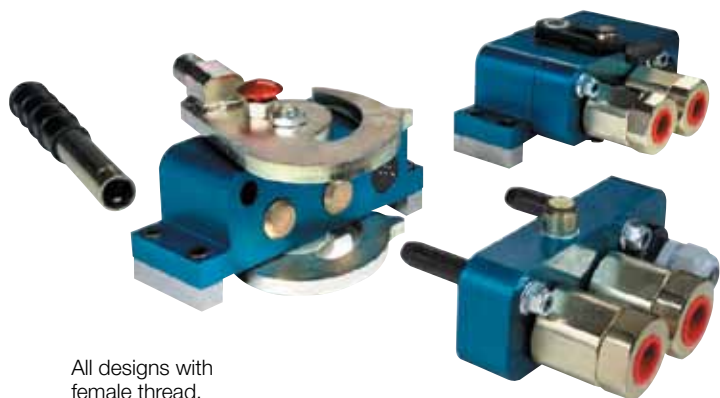

All designs with female thread.

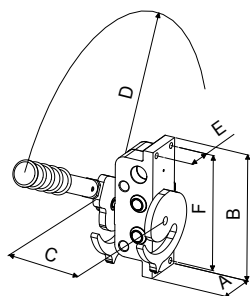

## Coupling Plate/Combinations

3/8" and 1/2"	
A	60 mm
B	189 mm
C	108 mm
D	278 mm
E	40 mm
F	173 mm

## Plug Plate/Combinations

	3/8"	1/2"
A	72 mm	84 mm
B	150 mm	150 mm
C	88 mm	88 mm

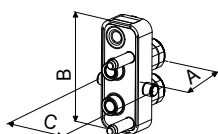

## Support Plate

3/8" and 1/2"	
A	52 mm
B	189 mm
C	86 mm
E	30 mm
F	173 mm

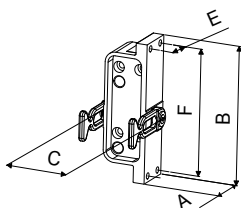

## Technical Description

Multiple connector system with locking lever and safety locking. Original TEMA plug-profile with spill-proof flat face design. Coupling body/plug fitted with high-flow valve system.

## Pressure Eliminator

All plugs are fitted with pressure eliminators to eliminate residual pressures up to maximum working pressure on the plug side (maximum 50 bar on the coupling side).

## 7-pole Electrical Connection

- Male part (coupling plate)
- Cable: 7 x 1,5 RDOE 5m
- Female part (plug plate)
- Cable: 7 x 1,5 RDOE 3m
- Not IP classified contact block: NBR
- Connector: (pins and casing) bronze, silver plated
- Electric connection box: Thermoplastic (POM)
- Pull relief (cable): PA/NBR
- Max. voltage: 24 V
- Max. current: 16 A\*

\* For return-current through cable, the total permitted current through the connector is maximum 16 A.

## Working Temperature

-30°C up to +100°C (NBR/PUR)

## Working Pressure

Max. pressure range:  
350 bar (safety factor 4:1)

## Attention:

Half the number of connections in the respective sizes.

## Flow Capacity with Oil with Viscosity of 32cSt at 40°C as per ISO 7241/2-2000

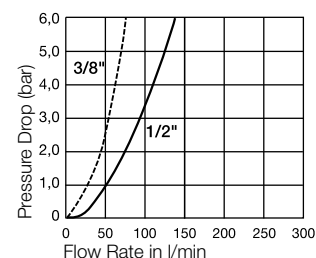

## Hydraulic Flow:

3/8" - 54 l/min (3 bar press. drop)  
1/2" - 97 l/min (3 bar press. drop)

## Nominal Diameter in mm:

3/8" - 10  
1/2" - 12,5

## Material

Coupling-/Plug plates	Aluminium, anodised-blue
Support Plate	Aluminium, anodised-blue
Protective Cap	Aluminium, anodised-blue, NBR-seal
Couplings and Plugs	Steel, zinc-plated, passivated (Cr3+), movable sleeves made of stainless steel AISI 304
Seals	NBR/PUR; replaceable profile ring on plug side
Locking Mechanism	Steel, zinc-plated, passivated (Cr3+)
Locking Button	Aluminium, anodised-red
Blank Plug	Thermoplastics (POM)

## Coupling Plate with Protective Cap (3/8")

## C-Line Compact

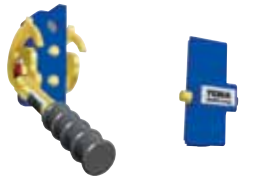
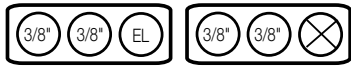

Locking Lever, detachable  
Locking Button right side

Coupling 3/8"	Electrical Connection (1 pc.)	Blank Plug 1/2"	Locking Lever Pos.	Locking Button	Weight gr.	Part Number
2	7-pole		right	right	6000	TMFC 33Y BBR*
2		1	right	right	4800	TMFC 33W BBR*
2	7-pole		left	left	6000	TMFC 33Y B**
2		1	left	left	4800	TMFC 33W B**

The protective cap is included.

The coupling plate is supplied complete with assembly kit TM-210K.

## Plug Plate with Support Plate (3/8")

## C-Line Compact

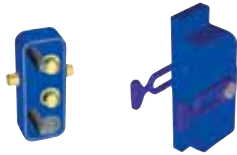

Plug 3/8"	Electrical Connection (1 pc.)	Blank Plug 1/2"	Locking Lever Pos.	Locking Button	Weight gr.	Part Number
2	7-pole				3600	TMMC 33Y
2		1			2800	TMMC 33W

The support plate is included.

The support plate is supplied complete with assembly kit TM-214K.

## Coupling Plate with Protective Cap (1/2")

## C-Line Compact

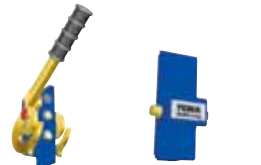
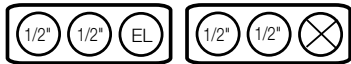

Locking Lever, detachable  
Locking Button left Side

Coupling 1/2"	Electrical Connection (1 pc.)	Blank Plug 1/2"	Locking Lever Pos.	Locking Button	Weight gr.	Part Number
2	7-pole		right	right	6100	TMFC 55Y BBR*
2		1	right	right	4800	TMFC 55W BBR*
2	7-pole		left	left	6100	TMFC 55Y B**
2		1	left	left	4800	TMFC 55W B**

The protective cap is included.

The coupling plate is supplied complete with assembly kit TM-210K.

## Plug Plate with Support Plate (1/2")

## C-Line Compact

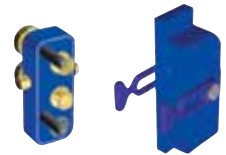
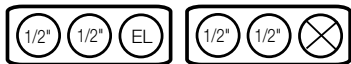

Plug 1/2"	Electrical Connection (1 pc.)	Blank Plug 1/2"	Locking Lever Pos.	Locking Button	Weight gr.	Part Number
2	7-pole				4100	TMMC 55Y
2		1			3300	TMMC 55W

The support plate is included.

The support plate is supplied complete with assembly kit TM-214K.

\* Designed to be used on the right hand side of the excavator arm. On wheel-loaders the mounting is on the inside of the right loading arm. (As seen from the drivers seat).

\*\* Designed to be used on the left hand side of the excavator arm. On wheel-loaders the mounting is on the inside of the left loading arm. (As seen from the drivers seat).



Body Size

1/2" up to 3/4"

Multi-Line

## C-Line Compact



All designs with female thread.

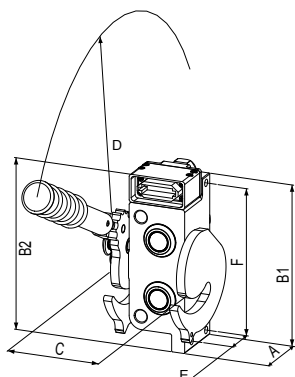

## Coupling Plate/Combinations

1/2" and 3/4"	
A	70 mm
B1	189 mm
B2	202 mm <sup>1)</sup>
C	115 mm
D	27 mm
E	40 mm
F	173 mm

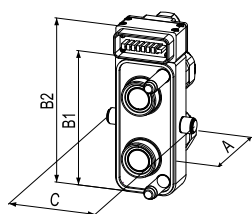

## Plug Plate/Combinations

1/2" and 3/4"	
A	97 mm
B1	148 mm
B2	181 mm <sup>1)</sup>
C	96 mm

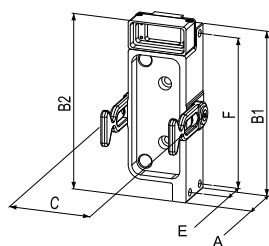

## Support Plate

1/2" and 3/4"	
A	52 mm
B1	189 mm
B2	202 mm <sup>1)</sup>
C	93 mm
E	30 mm
F	173 mm

<sup>1)</sup> with electrical plug

## Technical Description

Multiple connector system with locking lever and safety locking. Original TEMA plug-profile with spill-proof flat face design. Coupling body/plug fitted with high-flow valve system.

## Pressure Eliminator

All plugs are fitted with pressure eliminators to eliminate residual pressures up to maximum working pressure on the plug side (maximum 50 bar on the coupling side).

## 14-pole Electrical Connection

- Delivery exclusive of cables
- Protection category IP 67 (coupled)
- Screwed conductor connector: 0,5 – 1,5 mm<sup>2</sup>
- Pins and sleeves: copper coated
- Elect. junction box: Aluminium
- Traction relief: PA/NBR 9 –16 mm
- Max. voltage: 48 V
- Max. current: 10 A per core

## Working Temperature

-30°C up to +100°C (NBR/PUR)

## Working Pressure

Max. pressure range:  
350 bar (safety factor 4:1)

## Attention:

Half the number of connections in the respective sizes.

## Flow Capacity with Oil with Viscosity of 32cSt at 40°C as per ISO 7241/2-2000

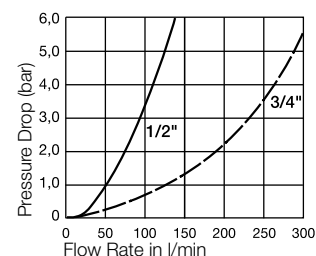

## Hydraulic Flow:

1/2" – 97 l/min (3 bar press. drop)  
3/4" – 240 l/min (3 bar press. drop)

## Nominal Diameter in mm:

1/2" – 12,5  
3/4" – 19

## Material

Coupling-/Plug plates	Aluminium, anodised-blue
Support Plate	Aluminium, anodised-blue
Protective Cap	Aluminium, anodised-blue, NBR-seal
Couplings and Plugs	Steel, zinc-plated, passivated (Cr3+), movable sleeves made of stainless steel AISI 304
Seals	NBR/PUR; replaceable profile ring on plug side
Locking Mechanism	Steel, zinc-plated, passivated (Cr3+)
Locking Button	Aluminium, anodised-red
Blank Plug	Thermoplastics (POM)

## Coupling Plate with Protective Cap (1/2")

## C-Line Compact



Coupling 1/2"	Electrical Connection (1 pc.)	Blank Plug 1/2"	Locking Lever Pos.	Locking Button	Weight gr.	Part Number
2			left	left	5100	TMFC 55 B**
2	14-pole		left	left	5400	TMFC 55 QB**
2			right	right	5100	TMFC 55 BBR*
2	14-pole		right	right	5400	TMFC 55 QBBR*



Locking Lever, detachable  
Locking Button right Side

The protective cap is included.

The coupling plate is supplied complete with assembly kit TM-210K.

## Plug Plate with Support Plate (1/2")

## C-Line Compact



Plug 1/2"	Electrical Connection (1 pc.)	Blank Plug 1/2"	Locking Lever Pos.	Locking Button	Weight gr.	Part Number
2					3600	TMMC 55
2	14-pole				3900	TMMC 55 Q

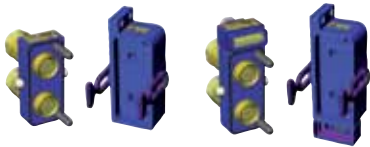

The support plate is included.

The support plate is supplied complete with assembly kit TM-214K.

## Coupling Plate with Protective Cap (3/4")

## C-Line Compact



Coupling 3/4"	Electrical Connection (1 pc.)	Blank Plug 3/4"	Locking Lever Pos.	Locking Button	Weight gr.	Part Number
2			left	left	5100	TMFC 77 B**
2	14-pole		left	left	5400	TMFC 77 QB**
2			right	right	5100	TMFC 77 BBR*
2	14-pole		right	right	5400	TMFC 77 QBBR*



Locking Lever, detachable  
Locking Button right Side

The protective cap is included.

The coupling plate is supplied complete with assembly kit TM-210K.

## Plug Plate with Support Plate (3/4")

## C-Line Compact



Plug 3/4"	Electrical Connection (1 pc.)	Blank Plug 3/4"	Locking Lever Pos.	Locking Button	Weight gr.	Part Number
2					3600	TMMC 77
2	14-pole				3900	TMMC 77 Q

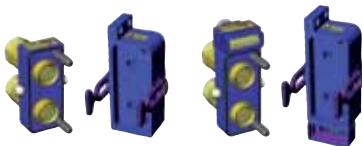

The support plate is included.

The support plate is supplied complete with assembly kit TM-214K.

\* Designed to be used on the right hand side of the excavator arm. On wheel-loaders the mounting is on the inside of the right loading arm. (As seen from the drivers seat).

\*\* Designed to be used on the left hand side of the excavator arm. On wheel-loaders the mounting is on the inside of the left loading arm. (As seen from the drivers seat).

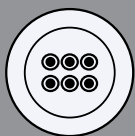

Body Size

3/8" up to 3/4"

Multi-Line

## C-Line Standard

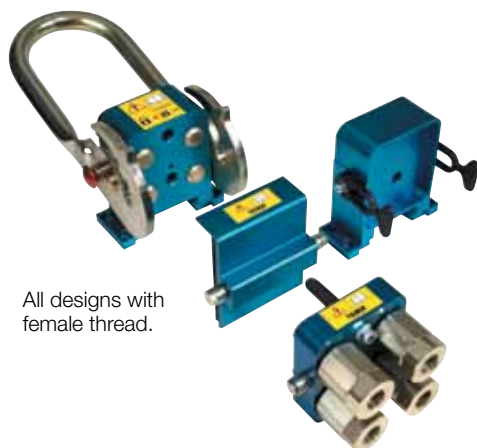

All designs with female thread.

## Coupling Plate/Combinations

	1/2", 3/8" + 1/2" Twin-arm lever	1/2", 3/8" + 1/2" Single lever, fixed	1/2", 3/8" + 1/2" Single lever, detachable
A	60 mm	60 mm	60 mm
B1	143 mm	143 mm	143 mm
B2	176 mm	176 mm	176 mm
C	160 mm	165 mm	170 mm
D	270 mm	290 mm	276 mm
E	40 mm	40 mm	40 mm
F	121 mm	121 mm	121 mm

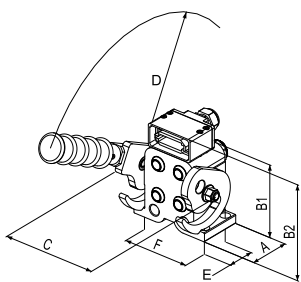

	4 x 3/8" All levers	3/4" + 1/2", 3/4" + 1/2" + 3/8" Twin-arm lever	3/4" + 1/2", 3/4" + 1/2" + 3/8" Single lever, fixed	3/4" + 1/2", 3/4" + 1/2" + 3/8" Single lever, det.
A	60 mm	70 mm	70 mm	70 mm
B1	103 mm	143 mm	143 mm	143 mm
B2	136 mm <sup>1)</sup>	176 mm <sup>1)</sup>	176 mm <sup>1)</sup>	176 mm <sup>1)</sup>
C	135 mm	160 mm	165 mm	170 mm
D	200 mm	270 mm	290 mm	276 mm
E	40 mm	50 mm	50 mm	50 mm
F	96 mm	121 mm	121 mm	121 mm

## Plug Plate/Combinations

	4 x 3/8"	1/2", 1/2" + 3/8"	3/4" + 1/2", 3/4" + 1/2" + 3/8"
A	72 mm	83 mm	95 mm
B1	101 mm	115 mm	115 mm
B2	134 mm <sup>1)</sup>	148 mm	148 mm
C	110 mm	135 mm	135 mm

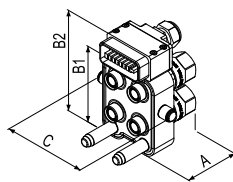

## Support Plate

	4 x 3/8"	all others
A	52 mm	52 mm
B1	103 mm	143 mm
B2	136 mm <sup>1)</sup>	176 mm <sup>1)</sup>
C	106 mm	141 mm
E	32 mm	30 mm
F	96 mm	121 mm

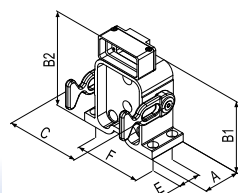

<sup>1)</sup> with electrical plug

## Technical Description

Multiple connector system with locking lever and safety locking. Original TEMA plug-profile with spill-proof flat face design. Coupling body/plug fitted with high-flow valve system.

## Working Pressure

Max. pressure range:  
350 bar (safety factor 4:1)

## Attention:

half the number of connections in the respective sizes.

## Pressure Eliminator

All plugs are fitted with pressure eliminators to eliminate residual pressures up to maximum working pressure on the plug side (maximum 50 bar on the coupling side).

## 7-pole Electrical Connection

- Male part (coupling plate)
- Cable: 7 x 1,5 RDOE 5m
- Female part (plug plate)
- Cable: 7 x 1,5 RDOE 3m
- Not IP classified contact block: NBR
- Connector: (pins and casing) bronze, silver plated
- Electric connection box: Thermoplastic (POM)
- Pull relief (cable): PA/NBR
- Max. voltage: 24 V
- Max. current: 16 A\*

\* For return-current through cable, the total permitted current through the connector is maximum 16 A.

## 14-pole Electrical Connection

- Delivery exclusive of cables
- Protection category IP 67 (coupled)
- Screwed conductor connector: 0,5 – 1,5 mm<sup>2</sup>
- Pins and sleeves: copper coated
- Elect. junction box: Aluminium
- Traction relief: PA/NBR 9 – 16 mm
- Max. voltage: 48 V
- Max. current: 10 A per core

## Working Temperature

-30°C up to +100°C (NBR/PUR)

## Flow Capacity with Oil with Viscosity of 32cSt at 40°C as per ISO 7241/2-2000

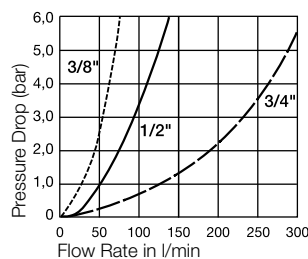

## Hydraulic Flow:

3/8" – 54 l/min (3 bar press. drop)  
1/2" – 97 l/min (3 bar press. drop)  
3/4" – 240 l/min (3 bar press. drop)

## Nominal Diameter in mm:





3/8" – 10  
1/2" – 12,5  
3/4" – 19

Material	
Coupling-/Plug plates	Aluminium, anodised-blue
Support Plate	Aluminium, anodised-blue
Protective Cap	Aluminium, anodised-blue, NBR-seal
Quick Connect Couplings/-Plugs	Steel, zinc-plated, passivated (Cr3+), movable sleeves made of stainless steel AISI 304
Seals	NBR/PUR; replaceable profile ring on plug side
Locking Mechanism	Steel, zinc-plated, passivated (Cr3+)
Locking Button	Aluminium, anodised-red
Blank Plug	Thermoplastics (POM)

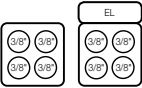

## Coupling Plate with Protective Cap (3/8")

## C-Line Standard

	Coupling 3/8"	Electrical Connection (1 pc.)	Blank Plug 3/8"	Locking Lever Pos.	Locking Button	Weight gr.	Part Number
 Twin-arm Lever  Locking Lever, Locking Button left Side	4			Twin-arm	left	3300	TMFC 3333
	4	14-pole		Twin-arm	left	3600	TMFC 3333 Q
	4			Twin-arm	right	3300	TMFC 3333 R
	4	14-pole		Twin-arm	right	3600	TMFC 3333 QR
 Single Lever, fixed  Locking Lever, Locking Button right Side	4			left	left	3300	TMFC 3333 A
	4	14-pole		left	left	3600	TMFC 3333 QA
	4			right	right	3300	TMFC 3333 AAR
	4	14-pole		right	right	3600	TMFC 3333 QAAR
 Single Lever, detachable  Locking Lever, Locking Button right Side	4			left	left	3300	TMFC 3333 B
	4	14-pole		left	left	3600	TMFC 3333 QB
	4			right	right	3300	TMFC 3333 BBR
	4	14-pole		right	right	3600	TMFC 3333 QBBR



Protective cap and assembly screws are included in the delivery.

## Plug Plate with Support Plate (3/8")

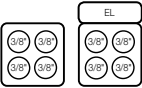
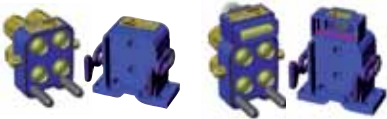
## C-Line Standard

	Plug 3/8"	Electrical Connection (1 pc.)	Blank Plug 3/8"	Locking Lever Pos.	Locking Button	Weight gr.	Part Number
 The support plate is included. The support plate is supplied complete with assembly kit TM-214K.	4					2900	TMMC 3333
	4	14-pole				3200	TMMC 3333 Q

## Coupling Plate with Protective Cap (1/2" + 3/8") C-Line Standard

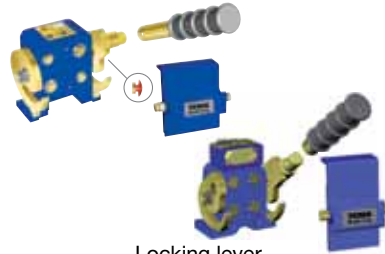
	Coupling 1/2"	Coupling 3/8"	Electrical Connection (1 pc.)	Blank Plug 1/2"	Locking Lever Pos.	Locking Button	Weight gr.	Part Number	
 <p style="text-align: center;">Twin-arm Lever</p>	2	2			Twin-arm	left	5900	TMFC 5533	
	2	2	14-pole		Twin-arm	left	6200	TMFC 5533 Q	
	1	2	7-pole		Twin-arm	left	7100	TMFC 5Y33	
	1	2		1	Twin-arm	left	5700	TMFC 5W33	
	2	2			Twin-arm	right	5900	TMFC 5533 R	
	2	2	14-pole		Twin-arm	right	6200	TMFC 5533 QR	
	1	2	7-pole		Twin-arm	right	7100	TMFC 5Y33 R	
	1	2		1	Twin-arm	right	5700	TMFC 5W33 R	
	 <p style="text-align: center;">Single Lever, fixed</p>	2	2			left	left	5500	TMFC 5533 A
		2	2	14-pole		left	left	5800	TMFC 5533 QA
1		2	7-pole		left	left	6700	TMFC 5Y33 A	
1		2		1	left	left	5400	TMFC 5W33 A	
2		2			right	right	5500	TMFC 5533 AAR	
2		2	14-pole		right	right	5800	TMFC 5533 QAAR	
1		2	7-pole		right	right	6700	TMFC 5Y33 AAR	
1		2		1	right	right	5400	TMFC 5W33 AAR	
 <p style="text-align: center;">Single Lever, detachable</p>		2	2			left	left	5700	TMFC 5533 B
		2	2	14-pole		left	left	6000	TMFC 5533 QB
	1	2	7-pole		left	left	6900	TMFC 5Y33 B	
	1	2		1	left	left	5500	TMFC 5W33 B	
	2	2			right	right	5700	TMFC 5533 BBR	
	2	2	14-pole		right	right	6000	TMFC 5533 QBBR	
	1	2	7-pole		right	right	6900	TMFC 5Y33 BBR	
1	2		1	right	right	5500	TMFC 5W33 BBR		
Protective cap and assembly screws are included in the delivery.									

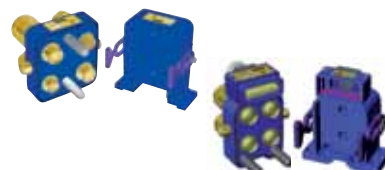

## Plug Plate with Support Plate (1/2" + 3/8") C-Line Standard

	Plug 1/2"	Plug 3/8"	Electrical Connection (1 pc.)	Blank Plug 1/2"	Locking Lever Pos.	Locking Button	Weight gr.	Part Number
	2	2					4600	TMMC 5533
	2	2	14-pole				4700	TMMC 5533 Q
	1	2	7-pole				4900	TMMC 5Y33
	1	2		1			4100	TMMC 5W33
Assembly screws and support plate are included in the delivery								

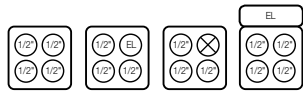
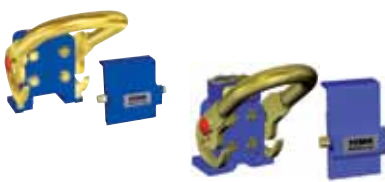

## Coupling Plate with Protective Cap (1/2")

## C-Line Standard

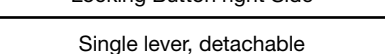
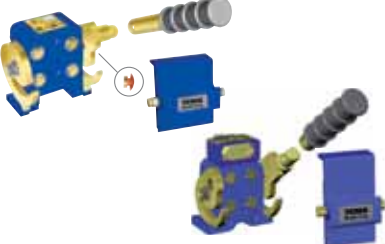
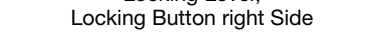
		Coupling 1/2"	Electrical Connection (1 pc.)	Blank Plug 1/2"	Locking Lever Pos.	Locking Button	Weight gr.	Part Number	
 Twin-arm Lever		4			Twin-arm	left	5900	TMFC 5555	
		4	14-pole		Twin-arm	left	6200	TMFC 5555 Q	
		3	7-pole		Twin-arm	left	7100	TMFC 555Y	
		3		1	Twin-arm	left	5700	TMFC 555W	
		4			Twin-arm	right	5900	TMFC 5555 R	
		4	14-pole		Twin-arm	right	6200	TMFC 5555 QR	
 Locking Lever, Locking Button left Side		3	7-pole		Twin-arm	right	7100	TMFC 555Y R	
		3		1	Twin-arm	right	5700	TMFC 555W R	
		4			left	left	5600	TMFC 5555 A	
 Single Lever, fixed		4	14-pole		left	left	5900	TMFC 5555 QA	
		3	7-pole		left	left	6800	TMFC 555Y A	
		3		1	left	left	5400	TMFC 555W A	
		4			right	right	5600	TMFC 5555 AAR	
		4	14-pole		right	right	5900	TMFC 5555 QAAR	
		3	7-pole		right	right	6800	TMFC 555Y AAR	
 Locking Lever, Locking Button right Side		3		1	right	right	5400	TMFC 555W AAR	
	 Single lever, detachable		4			left	left	5700	TMFC 5555 B
			4	14-pole		left	left	6000	TMFC 5555 QB
		3	7-pole		left	left	6900	TMFC 555Y B	
		3		1	left	left	5500	TMFC 555W B	
		4			right	right	5700	TMFC 5555 BBR	
		4	14-pole		right	right	6000	TMFC 5555 QBBR	
 Locking Lever, Locking Button right Side		3	7-pole		right	right	6900	TMFC 555Y BBR	
		3		1	right	right	5500	TMFC 555W BBR	

Protective cap and assembly screws are included in the delivery.



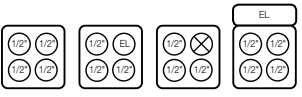
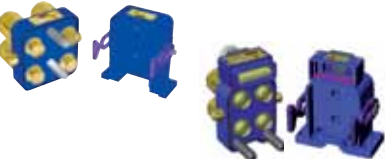

## Plug Plate with Support Plate (1/2")

## C-Line Standard

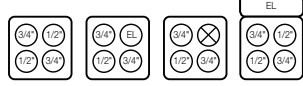

		Plug 1/2"	Electrical Connection (1 pc.)	Blank Plug 1/2"	Locking Lever Pos.	Locking Button	Weight gr.	Part Number
 Plug Plate with Support Plate		4					5100	TMMC 5555
		4	14-pole				5200	TMMC 5555 Q
		3	7-pole				5400	TMMC 555Y
		3			1		4600	TMMC 555W

Assembly screws and support plate are included in the delivery

## Coupling Plate with Protective Cap (3/4" + 1/2") C-Line Standard



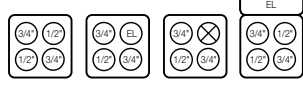





				Coupling 3/4"	Coupling 1/2"	Electrical Connection (1 pc.)	Blank Plug 1/2"	Locking Lever Pos.	Locking Button	Weight gr.	Part Number		
 <p>Twin-arm Lever</p> <p>Locking Lever, Locking Button left Side</p>		2	2					Twin-arm	left	6600	TMFC 7755		
		2	2	14-pole				Twin-arm	left	6900	TMFC 7755 Q		
		2	1	7-pole				Twin-arm	left	7800	TMFC 775Y		
		2	1		1			Twin-arm	left	6400	TMFC 775W		
		2	2					Twin-arm	right	6600	TMFC 7755 R		
		2	2	14-pole				Twin-arm	right	6900	TMFC 7755 QR		
		2	1	7-pole				Twin-arm	right	7800	TMFC 775Y R		
		2	1		1			Twin-arm	right	6400	TMFC 775W R		
		 <p>Single Lever, fixed</p> <p>Locking Lever, Locking Button right Side</p>		2	2					left	left	6300	TMFC 7755 A
				2	2	14-pole				left	left	6600	TMFC 7755 QA
2	1			7-pole				left	left	7500	TMFC 775Y A		
2	1				1			left	left	6100	TMFC 775W A		
2	2							right	right	6300	TMFC 7755 AAR		
2	2			14-pole				right	right	6600	TMFC 7755 QAAR		
2	1			7-pole				right	right	7500	TMFC 775Y AAR		
2	1				1			right	right	6100	TMFC 775W AAR		
 <p>Single Lever, detachable</p> <p>Locking Lever, Locking Button right Side</p>				2	2					left	left	6400	TMFC 7755 B
				2	2	14-pole				left	left	6900	TMFC 7755 QB
		2	1	7-pole				left	left	7600	TMFC 775Y B		
		2	1		1			left	left	6200	TMFC 775W B		
		2	2					right	right	6400	TMFC 7755 BBR		
		2	2	14-pole				right	right	6900	TMFC 7755 QBBR		
		2	1	7-pole				right	right	7600	TMFC 775Y BBR		
2	1		1			right	right	6200	TMFC 775W BBR				
Protective cap and assembly screws are included in the delivery.													

## Plug Plate with Support Plate (3/4" + 1/2") C-Line Standard

				Plug 3/4"	Plug 1/2"	Electrical Connection (1 pc.)	Blank Plug 1/2"	Locking Lever Pos.	Locking Button	Weight gr.	Part Number
		2	2							5600	TMMC 7755
		2	2	14-pole						5700	TMMC 7755 Q
		2	1	7-pole						5900	TMMC 775Y
		2	1		1					5100	TMMC 775W
		Assembly screws and support plate are included in the delivery									

## Coupling Plate with Protective Cap (3/4" + 1/2" + 3/8")

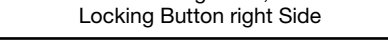



## C-Line Standard

					Coupling 3/4"	Coupling 1/2"	Coupling 3/8"	Electrical Connec. (1 pc.)	Blank Plug 1/2"	Locking Lever Pos.	Locking Button	Weight gr.	Part Number	
 Twin-arm Lever   Locking Lever, Locking Button left Side	2	1	1							Twin-arm	left	6600	TMFC 7753	
	2	1	1	14-pole						Twin-arm	left	6900	TMFC 7753 Q	
	2		1	7-pole							Twin-arm	left	7800	TMFC 77Y3
	2		1			1					Twin-arm	left	6400	TMFC 77W3
	2	1	1								Twin-arm	right	6600	TMFC 7753 R
	2	1	1	14-pole							Twin-arm	right	6900	TMFC7753 QR
	2		1	7-pole							Twin-arm	right	7800	TMFC 77Y3 R
	2		1								Twin-arm	right	6400	TMFC 77W3 R
 Single Lever, fixed   Locking Lever, Locking Button right Side	2	1	1							left	left	6300	TMFC 7753 A	
	2	1	1	14-pole						left	left	6600	TMFC 7753 QA	
	2		1	7-pole						left	left	7400	TMFC 77Y3 A	
	2		1			1				left	left	6100	TMFC 77W3 A	
	2	1	1							right	right	6300	TMFC 7753 AAR	
	2	1	1	14-pole						right	right	6600	TMFC 7753 QAAR	
	2		1	7-pole						right	right	7400	TMFC 77Y3 AAR	
	2		1			1				right	right	6100	TMFC 77W3 AAR	
 Single Lever, detachable   Locking Lever, Locking Button right Side	2	1	1							left	left	6400	TMFC 7753 B	
	2	1	1	14-pole						left	left	6700	TMFC 7753 QB	
	2		1	7-pole						left	left	7600	TMFC 77Y3 B	
	2		1			1				left	left	6200	TMFC 77W3 B	
	2	1	1							right	right	6400	TMFC 7753 BBR	
	2	1	1	14-pole						right	right	6700	TMFC 7753 QBRR	
	2		1	7-pole						right	right	7600	TMFC 77Y3 BBR	
	2		1			1				right	right	6200	TMFC 77W3 BBR	

Protective cap and assembly screws are included in the delivery.

## Plug Plate with Support Plate (3/4" + 1/2" + 3/8")

## C-Line Standard

					Plug 3/4"	Plug 1/2"	Plug 3/8"	Electrical Connec. (1 pc.)	Blank Plug 1/2"	Locking Lever Pos.	Locking Button	Weight gr.	Part Number
	2	1	1									5300	TMMC 7753
	2	1	1	14-pole								5400	TMMC 7753 Q
	2		1	7-pole								5700	TMMC 77Y3
	2		1			1						4800	TMMC 77W3

Assembly screws and support plate are included in the delivery

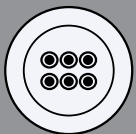

Multi-Line

# C-Line Accessories

## Support Plate for Plug Plate





C-Line

	Suitable Plug Plates with Part Number	Version	Weight gr.	Part number
	TMMC 33Y	C-Line Compact	1,1	TMPC 555
	TMMC 33W			
	TMMC 55Y			
	TMMC 55W			
	TMMC 55	C-Line Compact	1,5	TMPC 77
	TMMC 77			
	TMMC 55Q	C-Line Compact	1,6	TMPC 77Q
	TMMC 77Q			
	TMMC 3333	C-Line Standard	1,1	TMPC 3333
	TMMC 3333 Q	C-Line Standard	1,2	TMPC 3333 Q
	TMMC 5533	C-Line Standard	1,5	TMPC 5533
	TMMC 5Y33			
	TMMC 5W33			

	Suitable Plug Plates with Part Number	Version	Weight gr.	Part number
	TMMC 5533 Q	C-Line Standard	1,6	TMPC 5533 Q
	TMMC 5555	C-Line Standard	1,5	TMPC 5555
	TMMC 555Y			
	TMMC 555W			
	TMMC 5555 Q	C-Line Standard	1,6	TMPC 5555 Q
	TMMC 7755	C-Line Standard	1,5	TMPC 7755
	TMMC 775Y			
	TMMC 775W			
	TMMC 7755 Q	C-Line Standard	1,6	TMPC 7755 Q
	TMMC 7753	C-Line Standard	1,5	TMPC 7753
	TMMC 77Y3			
	TMMC 77W3			
	TMMC 7753 Q	C-Line Standard	1,6	TMPC 7753 Q



## Protective Caps/Lids

## C-Line

	Description	Weight gr.	Part number
	C-Line Compact	0,4	TMDC 1C
	C-Line Standard	0,6	TMDC 2
	C-Line Standard 4 x 3/8"	0,4	TMDC 1
	C-Line Standard 4 x 3/8" incl. 14-pole electrical plug	0,5	TMDC 1Q
	C-Line Standard incl. 14-pole electrical plug	0,7	TMDC 2Q
	C-Line Compact 2 x 3/4" or C-Line Compact 2 x 1/2"	0,5	TMDC 3
	C-Line Compact 2 x 3/4" or C-Line Compact 2 x 1/2" incl. 14-pole electrical plug	0,5	TMDC 3Q



## Welding Plate

## C-Line

	Description	Weight gr.	Part Number
	Universal welding plate for coupling plate C-Line compact design incl. two welding brackets and assembly screws for the coupling plate.	200	TM-210K
	Universal welding plate for support plate C-Line Standard 4 x 3/8" incl. two welding brackets and assembly screws for the support plate.	300	TM-210K2
	Universal welding plate for support plate C-Line Compact design incl. two welding brackets and assembly screws for the support plate.	300	TM-214K
	Universal installation kit comprising two welding plates for C-Line 2 x 1/2" + 2 x 3/4" incl. associated screws for the C-Line Compact coupling plates.	300	TM-258K

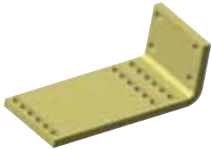

## Assembly Brackets

## C-Line

	Description	Weight gr.	Part Number
	Universal assembly bracket to be screwed or welded, (excl. screws). Can be cut and adapted to fit various tool carriers. (Self installation).	700	TM-FMP2
	Assembly bracket to be screwed, for Volvo L60-L180 (excl. screws) (for left hand mounting as seen from drivers seat).	1600	TM-FMP3K
	Assembly bracket to be screwed, for Volvo L60-L180 (excl. screws) (for right hand mounting as seen from drivers seat).	1600	TM-FMP4K



## Assembly Brackets

## C-Line

	Description	Weight gr.	Part Number
	Assembly bracket to be screwed, for Volvo L20-L45 (excl. screws).	700	TM-FMP2
	Assembly bracket to be screwed, for C-Line compact, for Volvo L20-L45 (excl. screws).	1600	TM-FMP3K



## Other Accessories

## C-Line

	Description	Weight gr.	Part Number
	Detachable handle - universal	200	TM-220-SP
	Detachable handle (4 x 3/8")	200	TM-242-SP
	Blank plug 3/8" for coupling plates on page 85, 90	30	MF3810P6-PLUGG
	Blank plug 3/8" for coupling plates on page 93	30	MF3810P7-PLUGG
	Blank plug 3/8" for plug plates	30	MF3821-PLUGG
	Blank plug 1/2" for coupling plates on page 85, 90, 91	40	MF5010P6-PLUGG
	Blank plug 1/2" for coupling plates on page 92, 93	50	MF5010P7-PLUGG
	Blank plug 1/2" for plug plates	40	MF5021-PLUGG
	Blank plug 3/4" for coupling plates on page 87, 92, 93	100	MF7510-PLUGG
	Blank plug 3/4" for plug plates	80	MF7521-PLUGG

## Electrical Contact





## C-Line

	Description	Weight gr.	Part Number
Plug 	Electrical plug, short, 7-pole, incl. 5 m cable and installation kit for coupling plate.	1900	TMEM2-P6-SP
	Electrical plug, long, 7-pole, incl. 5 m cable and installation kit for coupling plate.	1900	TMEM2-P6-SP
	Electrical closure, 7-pole, incl. 3 m cable and installation kit for plug plate.	1200	TMEF2-SP
Closure 	Electrical plug, short, 7-pole, without cable, incl. installation kit for coupling plate.	100	TMEM2-P6-00
	Electrical plug, long, 7-pole, without cable, incl. installation kit for coupling plate.	200	TMEM2-P7-00
	Electrical closure, 7-pole, without cable, incl. installation kit for plug plate.	100	TMEF2-00





## Electrical Contact

## C-Line

	Description	Weight gr.	Part Number
	Electrical closure, 14-pole, without cable, incl. installation kit for coupling plate.	300	STA 1410
	Electrical plug, 14-pole, without cable, incl. installation kit for plug plate.	300	STA 1420
	Electrical protective cap with installation kit for plug plate.	100	STA 1415
	Electrical protective cap with installation kit for support plate.	100	STA 1425

## Complete Electrical Set

## C-Line

	Description	Weight gr.	Part Number
	Complete electrical set, 14-pole, for retrofitting TMFC 3333 ... and TMMC 3333, incl. protective cap TMDC 1Q	1300	STA 14-K1
	Complete electrical set, 14-pole, for retrofitting TMFC 5533, TMMC 5533 and TMFC 5555, TMMC 5555, incl. protective cap TMDC2Q.	1300	STA 14-K21
	Complete electrical set, 14-pole, for retrofitting TMFC 7755 and TMMC 7755, incl. protective cap TMDC2W7755.	1300	STA 14-K22
	Complete electrical set, 14-pole, for retrofitting TMFC 7753 and TMMC 7753, incl. protective cap TMDC2Q7753.	1300	STA 14-K23
	Complete electrical set, 14-pole, for retrofitting TMFC 55..., TMMC 55 and TMFC 77..., TMMC 77, incl. Protective cap TMDC 3Q.	1300	STA 14-K3









## Electrical Cable for 14-pole Electrical Contact

## C-Line

	Description	Weight gr.	Part Number
	Electrical cable for 14-pole electrical contact, 18 x 0,75 mm <sup>2</sup> , PUR TMPU, running meter.	200	CAB18x075
	Electrical cable for 14-pole electrical contact, 18 x 1,5 mm <sup>2</sup> , PUR TMPU, running meter.	400	CAB18x150

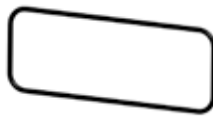



# Spare Parts Male Coupling Plate

# C-Line

	Description	Weight kg	Part Number
	Plug 3/8"	0,3	MF3821-SP
	Plug 1/2"	0,5	MF5021-SP
	Plug 3/4"	0,8	MF7521-SP
	Seal kit for MF3821 (3/8")	0,001	MF3800-PSPU
	Seal kit for MF5021 (1/2")	0,002	MF5000-PSPU
	Seal kit for MF7521 (3/4")	0,002	MF7500-PSPU
	Guiding pin with nut	0,08	TM-101-SP
	O-Ring outer C-Line Standard and Compact with 2 holes	0,005	TM-133-SP
	O-Ring outer C-Line Compact with 3 holes	0,005	TM-204-SP
	O-Ring outer C-Line Standard 4 x 3/8"	0,002	TM-230-SP
	Rubber loop for support plate. 2 rubber loops with washer and screw.	0,05	TM-158-SP
	Electrical plug, 14-pole	0,03	STA14F-SP

# Spare Parts Female Coupling Plate

# C-Line

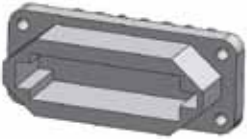
	Description	Weight kg	Part Number
	Coupling 3/8"	0,2	MF3810-SP
	Coupling 1/2"	0,2	MF5010-SP
	Coupling 3/4"	0,6	MF7510-SP
	Coupling 3/8" long; all versions with 3/4"	0,2	MF3810 P7-SP
	Coupling 1/2" long; all versions with 3/4"	0,3	MF5010 P7-SP
	Lock Device	0,03	TM-219-SP
	Locking Button	0,03	TM-103-SP
	Electrical closure, 14-pole	0,04	STA14S-SP



Body Size

1/4" and 3/8"

700 bar

3000-Series

**Technical Description**

High pressure coupler up to 700 bar. Screw locking mechanism.

**Advantages**

Screw type locking mechanism - high resistance to mechanical and hydraulic strengths. Ball or poppet valving configurations can be connected together with reduced impact on the flow capacities.

**Applications**

- Portable hydraulic rams
- Hydraulic jacks, rams and clamping devices
- Clamping hand tools
- Rescue equipment

**Working Temperature**

-30°C up to +110°C (NBR)  
-30°C up to +80°C (Polyurethane)  
depending on the medium.  
Special seals are available on request (see page 6 ff).

**Working Pressure**

Body Size	Max. Operating Pressure Connected
1/4"	700 bar
3/8"	700 bar

Material Coupling	Standard
Coupling Body	Steel
Sleeve	Steel
Valve	Steel
Springs	Steel
Seals 1/4"	NBR
Seals 3/8"	Polyurethane
Thread Body	Steel
Material Plug	Standard
Plug Body	Steel
Valve	Steel
Seals 1/4"	NBR
Seals 3/8"	Polyurethane
Seals	NBR
Valve Holder	Steel

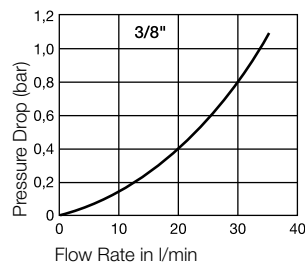
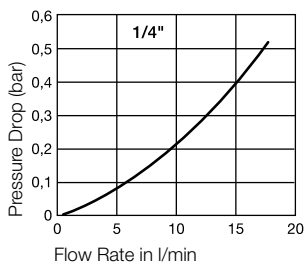
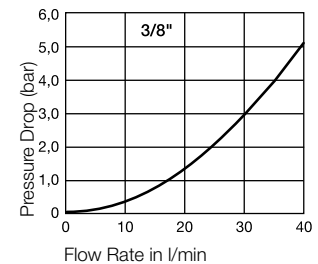
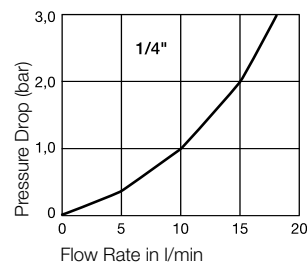
**Flow Capacity with Oil with Viscosity of 43cSt at 38°C as per ISO 7241/2-2000****Ball Valving****Poppet Valving**

## Couplings

## 3000-Series

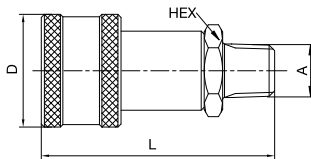
	Body Size	Connection A	Hex	L mm	D mm	D1 mm	Valving	Weight gr.	Part Number
 <p>Male NPTF Thread</p>	1/4"	1/4"	22 mm	60,5	28,5		Ball	115	3050-2
	1/4"	1/4"	22 mm	60,5	29		Poppet	121	3050-2P
	3/8"	3/8"	24 mm	72	35		Ball	220	3050-3
	3/8"	3/8"	1"	73	35		Poppet	225	3050-3P

## Plugs

## 3000-Series

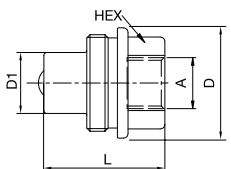
	Body Size	Connection A	Hex mm	L mm	D mm	D1 mm	Valving	Weight gr.	Part Number
 <p>Female NPTF Thread</p>	1/4"	1/4"	19	32	28	15,8	Ball	70	3010-2
	1/4"	1/4"	27	32	31	15,8	Poppet	85	3010-2P
	3/8"	3/8"	32	38	35	19,0	Ball	115	3010-3
	3/8"	3/8"	32	35	36,8	19,0	Poppet	110	3010-3P

## Dust Protection

## 3000-Series

	Body Size	Version	Part Number
	1/4"	for coupling	3005-2
	3/8"	for coupling	3005-3
	1/4"	for plug	3009-2
	3/8"	for plug	3009-3

## Seal-Kit

## 3000-Series

	Body Size	Material	Part Number
	1/4"	NBR	JT020114N0552
	3/8"	Polyurethane	JT01U28-18.72QE

**Technical Description**

Coupling for off-shore. Stainless Steel made to cope with very high work pressure in corrosive environment.

**Advantages**

Corrosion resistant.  
Double-shut-off valve – no leakage.  
Screw-to-connect-valve – connecting under pressure while disconnected.  
Dust caps for coupling and plug.

**Applications**

- Off-Shore

**Working Pressure**

SK10 750 bar  
SK06 1100 bar

**Working Temperature**

-25°C up to +100°C  
(NBR/FKM)  
depending on the medium.  
Special seals are available on request (see page 6 ff).

Material Coupling	SK10 (750bar)	SK06 (1100 bar)
Coupling Body	Wst No 1.4462	Wst No 1.4462
Sleeve	Wst No 1.4401	Wst No 1.4418
Valve	AISI 316	AISI 316
Springs	AISI 302	AISI 302
Seals	NBR / FKM	NBR / FKM
Valve Retainer	AISI 316	AISI 316
Material Plug	SK10 (750bar)	SK06 (1100 bar)
Plug Body	Wst No 1.4462	Wst No 1.4462
Valve	AISI 316	AISI 316
Springs	AISI 302	AISI 302
Seals	NBR / FKM	NBR / FKM
Valve Retainer	AISI 316	AISI 316

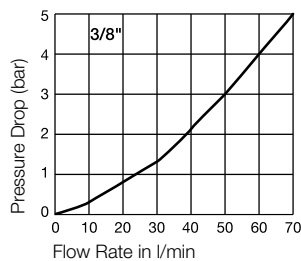
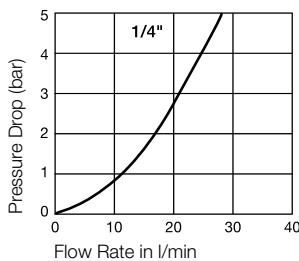
**Flow Capacity with Oil with Viscosity of 32cSt at 40°C as per ISO 7241/2-2000**

# Couplings

# SK-Series

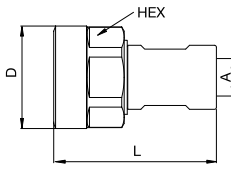
	Body Size	Connection A	HEX mm	L mm	D mm	Working Pressure	Part Number
 <p>Female Thread</p>	1/4"	ISO-G 1/4 ORB	36	64	40	1100 bar	SK0610 R
	3/8"	ISO-G 3/8 ORB	41	67	45	750 bar	SK1010 R

# Plugs

# SK-Series

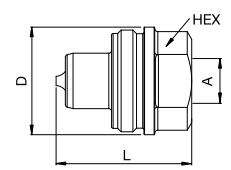
	Body Size	Connection A	HEX mm	L mm	D mm	Working Pressure	Part Number
 <p>Female Thread</p>	1/4"	ISO-G 1/4 ORB	27	44	35	1100 bar	SK0620 R
	3/8"	ISO-G 3/8 ORB	26	43	40	750 bar	SK1020 R

# Dust Protection

# SK-Series

Body Size	Version	Material	Part Number
1/4"	for coupling	POM	SK0615
1/4"	for plug	POM	SK0625
3/8"	for coupling	POM	SK1015
3/8"	for plug	POM	SK1025



Body Size

1/4"

800 bar

# FF2500-Series



### Technical Description

The coupling system of the FF series has double shut-off, dry break and single-handed operation. During uncoupling there is no oil loss, and during coupling there is no inclusion of air into the system.

### Advantages

Dry break quick connect coupling with minimum pressure drop. Single-handed operation. No oil loss during uncoupling. A safety closing ring prevents unintentional disconnection. Twice as safe through double sealing. Also available with pressure eliminator, i.e. connection is possible under static/residual pressure up to working pressure.

### Working Pressure

See charts.

### Working Temperature

-30°C up to +100°C (NBR) depending on the medium. Special seals are available on request (see page 6 ff).

### Available Valves



### Applications Area



Material Coupling	Standard / Pressure Eliminator
Coupling Body	Steel, nitrocarburizing
Sleeve	Steel hardened, zinc plated, passivated, sealed
Locking Ring	Brass, Zinc-iron coated, black passivated, sealed
Valve	Steel, zinc plated, passivated, sealed
Springs	AISI 301
Locking Balls	AISI 420 C
Seals	NBR/PUR
Valve Holder	Steel, yellow zinc plated, sealed
Thread Body	Steel, zinc plated, passivated, sealed
Material Plug	Standard / Pressure Eliminator
Plug Body	Steel hardened, zinc plated, passivated, sealed
Valve	Steel, nitrocarburizing
Springs	AISI 301
Seals	NBR/PUR
Valve Holder	Brass, hard-drawn
Thread Body	Steel, zinc plated, passivated, sealed

### Flow Capacity with Oil with Viscosity of 32cSt at 40°C as per ISO 7241/2-2000

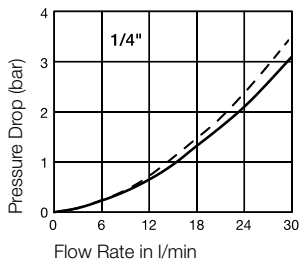

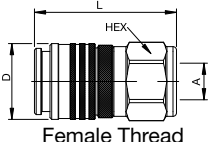

**Couplings****FF2500-Series Standard**

	Body Size	Connection A	Hex mm	L mm	D mm	Working Press. connect. in bar	Version	Seal	Part Number
 <p>Female Thread</p>	1/4"	G 1/4	27	65	30	800	Standard	NBR/PUR	FF2510

**Plugs****FF2500-Series Standard**

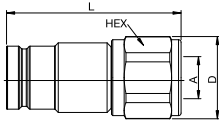
	Body Size	Connection A	Hex mm	L mm	D mm	Working Press. connect. in bar	Version	Seal	Part Number
 <p>Female Thread</p>	1/4"	G 1/4	25	74	28	800	Standard	NBR/PUR	FF2520

**Plugs****FF2500-Series Pressure Eliminator**

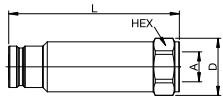
	Body Size	Connection A	Hex mm	L mm	D mm	Working Press. connect. in bar	Version	Seal	Part Number
 <p>Female Thread</p>	1/4"	G 1/4	25	99,2	28	800	Press. Eliminator	NBR/PUR	FF2521

**Dust Protection****FF2500-Series**

	Body Size	Version	L mm	D mm	Material	Color	Part Number
	1/4"	for coupling	190	24	PVC	Blue	FF2516
	1/4"	for plug	190	24	PVC	Blue	FF2526

**Seal-Kit****FF2500-Series**

Body Size	Version	Material	Part Number
1/4"	for plugs	NBR	FF2500-PSNPU



Body Size

1/4"

1000 bar

# HP1000-Series



### Technical Description

The Tema high pressure coupling was specially developed for use in industrial machinery, salvage devices and testing equipment. This series is galvanised and produced in steel. The plug part and the sleeve are hardened and galvanised in steel. The coupling can be supplied either with or without additional safety lock.

### Advantages

High flow as a result of optimised valve design. Additional plug sealing via polymer valve casing, to guarantee high reliability seals even with second-hand plugs. Tema high pressure couplings are supplied with dust caps inclusive!

### Seals

Coupling: bonded seal washer  
Plug: bonded seal or innercone

### Working Pressure

1000 bar

### Working Temperature

-30°C up to +100°C (NBR) depending on the medium. Special seals are available on request (see page 6 ff).

### Available Valves



### Applications Area



Material Coupling	Standard
Coupling Body	Steel, zinc plated, passivated, sealed
Sleeve	Steel, hardened, zinc plated, passivated, sealed
Valve	Steel, zinc plated, passivated, sealed
Springs	AISI 302
Locking Balls	AISI 420 C
Seals	NBR
Inner Sleeve	POM
Plug	Standard
Plug Body	Steel, hardened, zinc plated, passivated, sealed
Valve	Steel, zinc plated, passivated, sealed
Springs	AISI 302
Seals	NBR
Valve Retainer	Steel, zinc plated, passivated

### Flow Capacity with Oil with Viscosity of 32cSt at 40°C as per ISO 7241/2-2000

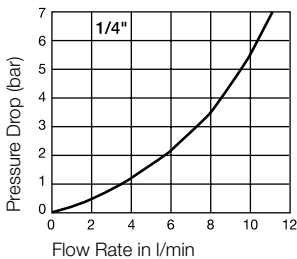

## Couplings

## HP1000-Series

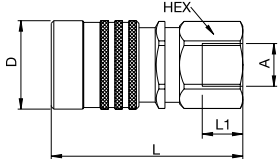
	Conne- ction A	Hex mm	L mm	L1 mm	D mm	Safety Locking	Work. Pressure connect. in bar	Work. Pressure disconnect. in bar	Burst. Pressure connect.in bar	Part Number
 <p>Female Thread</p>	G 1/4	24	59	12	27	without	1000	1000	>3000	HP10104131
	G 1/4	24	59	12	27	with	1000	1000	>3000	HP10104132
	1/4"-18 NPTF	24	59	12	27	without	1000	1000	>3000	HP10105131
	1/4"-18 NPTF	24	59	12	27	with	1000	1000	>3000	HP10105132
	G 3/8	24	59	12	27	without	1000	1000	>3000	HP10104171
	G 3/8	24	59	12	27	with	1000	1000	>3000	HP10104172
	3/8"-18 NPTF	24	59	13	27	without	1000	1000	>3000	HP10105171
	3/8"-18 NPTF	24	59	13	27	with	1000	1000	>3000	HP10105172

## Plugs

## HP1000-Series

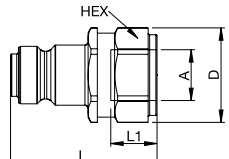
	Conne- ction A	Hex mm	L mm	L1 mm	D mm	Safety Locking	Work. Pressure connect. in bar	Work. Pressure disconnect. in bar	Burst. Pressure connect.in bar	Part Number	
 <p>Female Thread</p>	G 1/4	22	37	12	24,5		1000	1000	>3000	HP1020413	
	1/4"-18 NPTF	22	37	12	24,5		1000	1000	>3000	HP1020513	
	G 3/8	24	37	12	24,5		1000	1000	>3000	HP1020417	
	3/8"-18 NPTF	24	37	13	24,5		1000	1000	>3000	HP1020517	

## Dust Protection

## HP1000-Series

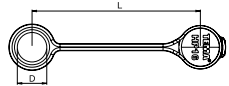
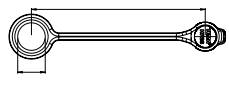
	Version	L mm	D mm	Material	Color	Part Number
	for coupling	120	21	PVC	Blue	HP16
	for coupling	125		Aluminium	Red	HP16ARD
	for plug	120	19	PVC	Blue	HP26
	for plug	140		Aluminium	Red	HP26ARD



Body Size

1/4"

1500 bar

# HP1500-Series



### Technical Description

The Tema high pressure coupling was specially developed for use in bolt tensioning equipment. This series is produced in steel. The plug bodies and the sleeves are black galvanised. The coupling can be supplied either with or without additional safety lock.

### Advantages

High flow as a result of optimised valve design. Additional plug sealing via polymer valve casing, to guarantee high reliability seals even with second-hand plugs. Tema high pressure couplings are supplied with dust caps inclusive!

### Seals

Metal sealing cone threaded adapters/metal sealing cone adapters.

### Working Pressure

1500 bar

### Working Temperature

-30°C up to +100°C (NBR) depending on the medium. Special seals are available on request (see page 6 ff).

### Available Valves



### Applications Area



Material Coupling	Standard
Coupling Body	Steel, zinc-nickel coated, black passivated, sealed
Sleeve	Steel, hardened, zinc-iron coated, black passivated, sealed
Valve	Steel, zinc plated, passivated, sealed
Springs	AISI 302
Locking Balls	AISI 420 C
Seals	NBR
Inner Sleeve	POM
Plug	Standard
Plug Body	Steel, hardened, zinc-iron coated, black passivated, sealed
Valve	Steel, zinc plated, passivated, sealed
Springs	AISI 302
Seals	NBR
Valve Retainer	Steel, zinc plated, passivated

### Flow Capacity with Oil with Viscosity of 32cSt at 40°C as per ISO 7241/2-2000

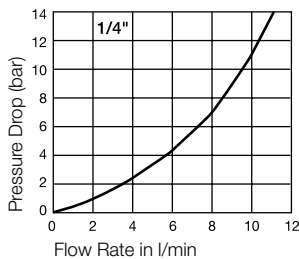

## Couplings

## HP1500-Series

	Conne- ction A	Hex mm	L mm	L1 mm	D mm	Safety Locking	Work. Pressure connect. in bar	Work. Pressure disconnect. in bar	Burst. Pressure connect.in bar	Part Number
<p>Female Thread</p>	G 1/4	24	59	12	27	without	1500	1500	>3500	HP15104131
	G 1/4	24	59	12	27	with	1500	1500	>3500	HP15104132
	1/4"-18 NPTF	24	59	12	27	without	1500	1500	>3500	HP15105131
	1/4"-18 NPTF	24	59	12	27	with	1500	1500	>3500	HP15105132
	G 3/8	24	59	12	27	without	1500	1500	>3500	HP15104171
	G 3/8	24	59	12	27	with	1500	1500	>3500	HP15104172
	3/8"-18 NPTF	24	59	13	27	without	1500	1500	>3500	HP15105171
	3/8"-18 NPTF	24	59	13	27	with	1500	1500	>3500	HP15105172

## Plugs

## HP1500-Series

	Conne- ction A	Hex mm	L mm	L1 mm	D mm	Safety Locking	Work. Pressure connect. in bar	Work. Pressure disconnect. in bar	Burst. Pressure connect.in bar	Part Number	
<p>Female Thread</p>	G 1/4	22	38	12	24,5		1500	1500	>3500	HP1520413	
	1/4"-18 NPTF	22	38	12	24,5		1500	1500	>3500	HP1520513	

## Dust Protection

## HP1500-Series

	Version	L mm	D mm	Material	Color	Part Number
	for coupling	120	21	PVC	Blue	HP16
	for coupling	125		Aluminium	Red	HP16ARD
	for plug	120	19	PVC	Blue	HP26
	for plug	140		Aluminium	Red	HP26ARD

Up to 2000 bar

# High Pressure Adapters



### Technical Description

Range of adapters developed for HP1000 and HP1500 series. To achieve other thread ports then existing in the standard range.

### Advantages

The adapters makes the HP series more flexible and easy to connect to different fittings and hose packages.

### Seals

Various - depending on adapter type

### Working Pressure

Various - from 1000 to 2000 bar

### Working Temperature

-30°C up to 100°C

Material	Standard
Adapters	Steel, Zinc plated and passivated

## High Pressure Adapters

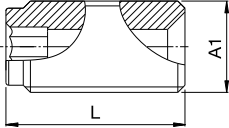
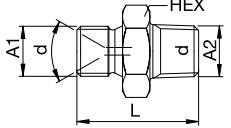
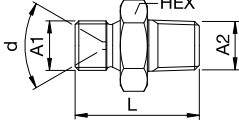
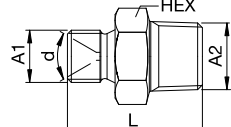
	Conne- ction A1	Seal 1	Connection A2	Seal 2	Hex mm	L mm	Working Pressure bar	Part Number
	G 1/4	Rubber / Steel				25	1000	HP13-01
	G 1/4	Rubber / Steel	1/4-18 NPTF	Inside Thread	21	32	1000	HP13-02
	G 1/4	Rubber / Steel	R 1/4	Inside Thread	21	33	1000	HP13-03
	G 1/4	Rubber / Steel	3/8-18 NPTF	Inside Thread	21	34	1500	HP13-04

# High Pressure Adapters

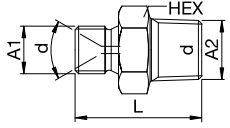
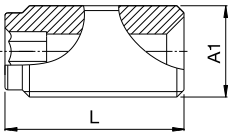
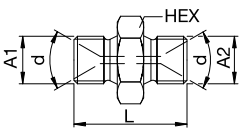
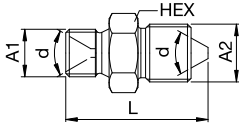
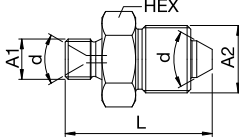
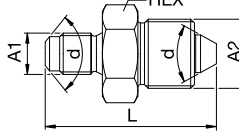
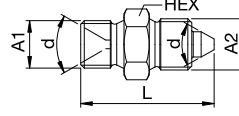
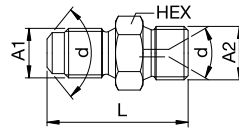
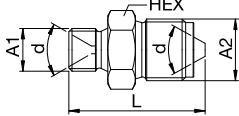
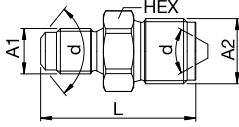
	Conne- tion A1	Seal 1	Connection A2	Seal 2	Hex mm	L mm	Working Pressure bar	Part Number
	G 1/4	Rubber / Steel	R 3/8	Inside Thread	21	35	1000	HP13-05
	G 1/4	Rubber / Steel				25	1500	HP13-06
	G 1/4	Inner Cone 60°	G 1/4	Inner Cone 60°	21	31,3	2000	HP13-07
	G 1/4	Inner Cone 60°	M 16 x 1,5	Outside Cone 60°	19	39,4	2000	HP13-08
	G 1/4	Inner Cone 60°	M 22 x 1,5	Outside Cone 60°	27	48	2000	HP13-09
	G 1/4	Outside Cone 120°	M 22 x 1,5	Outside Cone 60°	27	54,5	2000	HP13-10
	G 1/4	Inner Cone 60°	9/16-18 UNF	Outside Cone 60°	17	37	2000	HP13-11
	G 1/4	Outside Cone 120°	9/16-18 UNF	Inner Cone 60°	17	37,5	2000	HP13-12
	G 1/4	Inner Cone 60°	3/4-16 UNF	Outside Cone 60°	21	42	2000	HP13-13
	G 1/4	Outside Cone 120°	3/4-16 UNF	Outside Cone 60°	21	48,5	2000	HP13-14

**Technical Description**

The design of the Tema System 100 allows the check of static and dynamic pressures as well as vacuum. With the integrated self-venting device (as standard), it is easy to evacuate any inclusions. This guarantees an accurate display of the measured value, especially with dynamic pressures. The measuring plugs are available with various connection options. They have very small dimensions and can be fitted very easily to the equipment. Thanks to the design and choice of materials, the plugs are maintenance-free. The measuring device with the pressure gauge is fitted with a Tema quick connect coupling. This guarantees coupling to the

measuring plugs in a matter of seconds. With the shut-off device in the plug and in the body of the coupling, the Tema System 100 allows a dry break, during coupling as well as during uncoupling. For measuring at a distance, a flexible extension cable is available; this can be coupled between the measuring plug and the measuring system. Thanks to its wide range of connections, the Tema System 100 is a versatile and flexible measuring system.

**Maximum Working Pressure**

Measuring plug 120: 400 bar  
Other parts: 600 bar

**Complete Hydraulic Set****System 100**

	Description	Part Number
<p><b>The Tema System 100 Complete Set is delivered in a plastic case and contains the following parts:</b></p> <p>1 piece measuring handle 101-2 and pressure</p> <p>1 piece measuring handle 101-2 and pressure gauge of your choice*</p> <p>1 piece measuring plug 120</p> <p>1 piece measuring cable 130, length 2,5 m, complete</p> <p>1 piece adapter 135, G 1/4" i. x G 1/8" o.</p> <p>1 piece adapter 136, G 1/8" i. x G 1/4" o.</p> <p>In the measuring case there is additional room for two further pressure gauges as well as an adapter 139. If two pressure gauges are required, the part number is, for example, 106-13 (Complete Set with one pressure gauge 0-100 bar and one pressure gauge 0-40 bar).</p> <p>* If measuring handle 101-21A is required instead of 101-2, this must be added to the order.</p>	Complete set not including pressure gauge	101
	Complete set with 1 pressure gauge -1 to +1,5 bar	104
	Complete set with 1 pressure gauge 0 to +25 bar	112
	Complete set with 1 pressure gauge 0 to +60 bar	114-QC
	Complete set with 1 pressure gauge 0 to +250 bar	107-QC
	Complete set with 1 pressure gauge 0 to +400 bar	108
	Complete set with 1 pressure gauge 0 to +600 bar	109



# Measuring Plugs

### Technical Description

Thanks to their advanced design, the measuring plugs are reliable components in our measuring device. Made of hardened steel. The measuring plugs are maintenance free and are designed for temperatures from -40°C up to +110°C. The integrated valve seals up to a 90% vacuum. All mechanical parts in the measuring plug are made of corrosion resistant materials. Two different type of sealing (see picture on the right side). Available with two different types of covering cap.

- Fully sealed
- Maintenance-free
- Metal-to-metal seal

### A Type of seal

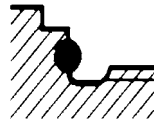

### B Type of seal

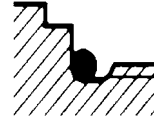

### Maximum Working Pressure

Measuring plug 120: 400 bar  
Other parts: 600 bar



## Measuring Plugs

## System 100

Connec- tion A	Description	Type of seal	L mm	L1 mm	HEX mm	Weight gr.	Part Number
G 1/8	with plastic cap	A	29	7,5	15	20	120
G 1/8	with metal cap	A	29	7,5	15	20	120-126
G 1/4	with plastic cap	A	36	11	18	35	121-125
G 1/4	with metal cap	A	36	11	18	35	121-126
G 1/4	with plastic cap	B	36	11	18	35	122-125
G 1/4	with metal cap	B	36	11	18	35	122-126
M 12 x 1,5	with plastic cap	A	36	11	18	35	123-125
M 12 x 1,5	with metal cap	A	36	11	18	35	123-126
M 14 x 1,5	with plastic cap	A	36	11	20	40	124-125
M 14 x 1,5	with metal cap	A	36	11	20	40	124-126
M 10 x 1	with plastic cap	A	29	7,5	15	40	128-125
M 10 x 1	with metal cap	A	29	7,5	15	40	128-126

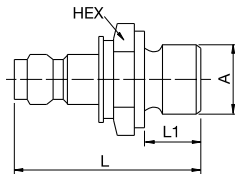

## Measuring Plug Accessories

## System 100

	Description	Part Number
	Plastic cap made of soft PVC	125-QC
	Metal cap with O-ring seal. Quick-lock type coupling on plug. Extra safety. Up to 750 bar.	126K
	Quick connect coupling for measuring plug with integrated shut-off valve. Seal made of FKM. G 1/8 male thread.	150
	Adapter coupling female thread G 1/4"	150-137

# Pressure Gauge/Measuring Handle/Self-Venting Block



## Pressure Gauge

- Filled with glycerine – suitable for temperatures to -40°C
- Special seal – quick change
- Measuring accuracy  $\pm 1,6\%$
- Diameter 63 mm
- Pressure gauge connection G 1/4", male thread
- Scale with double graduation (MPa + bar)

## Measuring Handle

Measuring handle 101-2 is used for low pressures up to max. 60 bar.

- System 100 – time-saving quick connect couplings
- Shut-off valve in coupling body and plug – dry break

Measuring handle 101-21A can be coupled even under full working pressure.

## Self-Venting Block

In order to obtain exact measured values (particularly with dynamic pressure measurements), it is essential that there should be no air bubbles trapped between the measuring plug and the pressure gauge. This can be checked simply and effectively with the Tema 100 Measuring System, since the air bubbles can easily be removed. It is possible to vent the system at maximum working pressure by using the venting screw.

## Pressure Gauge

## System 100

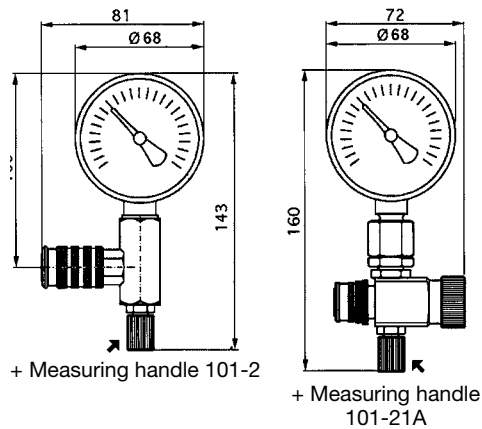

	Description	Part Number
Dimension Pressure gauge + measuring handle:	-1 to +1,5 bar	MAN 04
	0 to +6 bar	MAN 15
	0 to +25 bar	MAN 12
	0 to +60 bar	MAN 14
	0 to +250 bar	MAN 07
	0 to +400 bar	MAN 08
	0 to +600 bar	MAN 09
	Rubber guard for pressure gauge	100-40

Dimension Pressure gauge + measuring handle:



## Measuring Handle/Self-Venting Block

## System 100

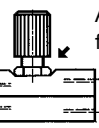
	Description	Part Number
	Measuring handle	101-2
	Measuring handle can be coupled under pressure	101-21A
	Self-venting block	101-3-QC

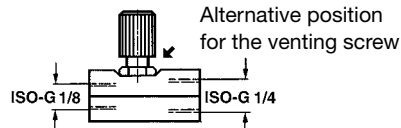

# High-Pressure Hoses

### Technical Description

Tema high-pressure hose – produced for measurements and mini-hydraulic systems. Exact selection of materials and production under strict control contribute to the satisfaction and reliable safety of the product. Max. working pressure 630 bar.

### Material

Inner and outer hose: high-quality POLYAMIDE  
Pressure carrier: KEVLAR

**Caution: If the hoses are to be used for compressed air, this must be mentioned in the order.**

### Advantages

- Remains flexible, even under full working pressure, thanks to its small external dimensions and a suitable choice of materials.
- Resistant to all mineral and most synthetic oils
- Resistant to ageing
- No increase in volume (no differences in measurements)
- Temperature range from -40°C up to +100°C

In order to achieve optimal durability, the hoses can be strengthened with a spring at each end. Add-on code "F" after the itemnumber of each connection.



### Ordering example for a complete high-pressure hose

	B	C	D
200K PA hose	1,6 Total- length m	210F G 1/8" Female thread + spring	240 Pressure gauge connect. G 1/4"

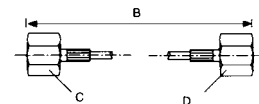

### Pressures





Type	Work. Pressure	Burst Pressure	Inner Dimens.	Outer Dimens.
200K	630 bar	2000 bar	2,0 mm	4,9 mm
400K	500 bar	2000 bar	4,1 mm	8,0 mm

Temperature range from -40°C to +93°C.

## Connections

## System 100 High-Pressure Hoses

Caution! The hoses are produced in various lengths  
Please specify hose and/or total length incl. connecting fittings. Design subject to alterations.

	Description	DN	Part Number
	G 1/8" female thread	2	210-QC
	G 1/8" male thread	2	220
	Pressure gauge connection G 1/4" female thread	2	240
	M 16 x 2,0 female thread for measuring plug		270

# Measuring Cable

# System 100

	Description	Part Number
Measuring cables in other designs and lengths on request.		
	Measuring cable for coupling the measuring handle 101-2 to measuring plugs.	130
	Supplied as standard with measuring plug (120) and coupling (150): 2,5 m.	

# Accessories

# System 100

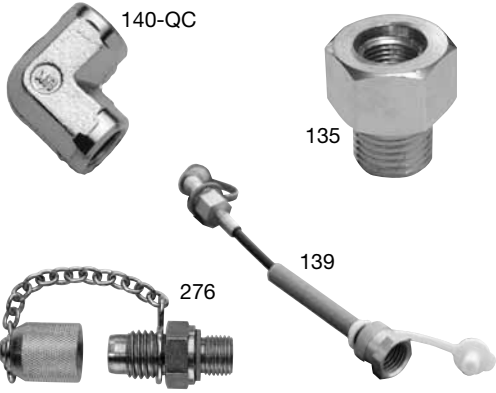
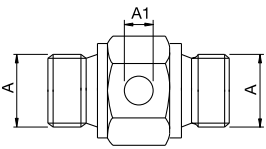
	Thread	Description	Part Number
	G 1/4 i. x G 1/8 o.	Adapter	135
	G 1/8 i. x G 1/4 i.	Adapter	136
	G 1/8 i. x G 1/4 o.	Adapter	137
	M 16	Changeover adapter for measuring plug	139
	G 1/8 i. x G 1/8 i.	Angle 90°	140-QC
		Plastic case (without picture)	101-1
	M 16 x 2 / G 1/4	Measuring plug	276
	M 16 x 2 / G 3/8	Measuring plug	277
	A: G 1/4; A1: G 1/8	Double plug with connecting thread for measuring plug	DNT2-1





# PJS Series



### Technical Description

The PJ/PJS series was specially developed for hydraulic diagnosis. Using the PJS system, oil quality and oil pressure can be determined by extracting oil directly from the plug. The components are produced in steel, galvanised in the connection and conform to norm SAE J 1502.

The PJS plug can be used both to test the oil and to extract oil.

### Advantages

The FlatFace design makes it easier to clean out dirt. Optimised oil intervals save time, labour and operating capital. The easy-grip, knurled locking sleeve makes coupling and uncoupling easy. Sampling also in working pressure circuits.

### Working Pressure

See information below.

### Working Temperature

-30°C up to +100°C (NBR)

### Material Coupling

Coupling Body	Steel, zinc plated, passivated, sealed
Sleeve	Steel, zinc plated, passivated, sealed
Valve	Steel/brass
Spring	AISI 301
Locking Balls	AISI 420 C
Seals	NBR

### Material Plug

Plug Body	Steel, zinc plated, passivated, sealed
Valve	Steel, zinc plated, passivated, sealed
Spring	AISI 301
Seals	NBR

### Applications Area



## Couplings

## PJS-Series

Connection A	Description	HEX mm	L mm	L1 mm	D mm	Working Press. bar	Part Number
<p>Female Thread</p>	1/8"-27 NPT	24	53	8	27	415	SJ18FN
	1/8"-27 NPT	24	53	8	27	415	SJS18FN
	1/4"-18 NPT	24	53	12	27	415	SJ14FN
	1/4"-18 NPT	24	53	12	27	415	SJS14FN

## Plugs

## PJS-Series

Connection A	Description	HEX mm	L mm	L1 mm	D mm	Working Press. bar	Part Number
<p>Male Thread</p>	7/16"-20 UNF	11/16"	45	9		415	PJ716U
	7/16"-20 UNF	11/16"	45	9		415	PJS716U
	9/16"-18 UNF	11/16"	43	10		415	PJ916U
	9/16"-18 UNF	11/16"	43	10		415	PJS916U

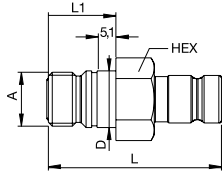

Male Thread Bulkhead Mounting

Connection A	Description	HEX	L mm	L1 mm	D mm	Working Press. bar	Part Number
9/16"-18 UNF	for Diagnostic	11/16"	46	18	15	415	PJ916FQ
9/16"-18 UNF	for Diagnostic and Fluid Sampling	11/16"	46	18	15	415	PJS916FQ



**Technical Description**

Diagnostic couplings provide easily accessible test points for performance testing of hydraulic and pneumatic systems. Easily incorporated into original equipment or retrofitted to existing circuits, PD plugs meet or exceed SEA J 1502 and ISO 15171-1 design and performance specification.

**Advantages**

Carbon steel for couplers. High tensile steel for plugs. Also available in brass on request. Ball locking mechanism. Flush-faced poppet valve for a minimal air inclusion when connecting, minimal fluid loss during disconnection and for an easy cleaning. The sealing and locking groove are induction hardened to resist mechanical abuse and brinelling while leaving toughness. A safety sleeve lock prevents accidental disconnection. Push-to-connect operation allows one hand operation when connecting the coupling.

**Applications**

- Industrial equipment
- Mobile equipment
- Agricultural equipment

**Working Pressure**

See chart.

**Working Temperature**

-40°C up to +110°C (NBR) depending on the medium. Special seals are available on request (see page 6 ff).

**Material Coupling**

Body	Steel
Sleeve	Steel
Valve	Steel
Valve Sleeve	Steel
Springs	Steel
Seals	Nitrile
Back-up Rings	PTFE
Valve body	Steel

**Material Plug**

Body	Steel
Seals	Nitrile
Valve	Steel
Spring	Steel
Retainer	Steel

**Options:**

1. For some end configurations, test points are also available in brass and stainless steel AISI 316.
2. Other metric end configurations are available upon request.
3. Possibility to have test point connectable under pressure up to 420 bar. Please contact your Parker sales engineer.

**Flow Capacity with Oil with Viscosity of 43cSt at 38°C as per ISO 7241/2-2000**

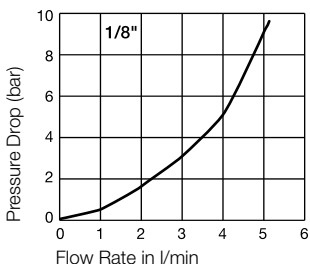



# Couplings

# PD-Series

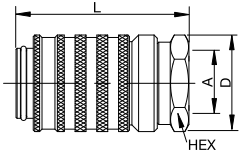
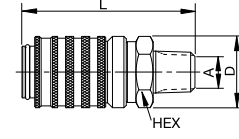
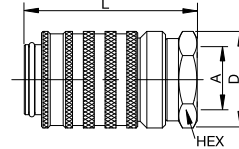
	Body Size	Connec- tion A	Tube Size	Hex	L mm	L1 mm	D mm	Weight gr.	Part number	
 <p>Female NPTF Thread – SAE J 476</p>	1/8"	1/8"-27		13/16"	42,4		24,4	90	PD222	
	1/8"	1/4"-18		13/16"	53,8		24,4	113	PD242	
 <p>Male NPTF Thread – SAE J 476</p>	1/8"	1/4"-18		13/16"	57,4		24,4	104	PD243	
 <p>Female UNF Thread – SAE J 1926</p>	1/8"	9/16"-18		13/16"	53,8		24,4	109	PD260	

# Plugs

# PD-Series

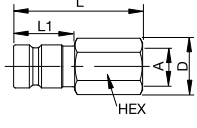
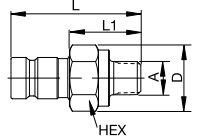
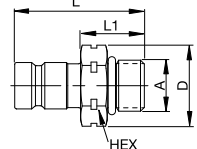
	Body Size	Connec- tion A	Tube Size	Hex	L mm	L1 mm	D mm	Weight gr.	Part number	
 <p>Female NPTF Thread – SAE J 476</p>	1/8"	1/8"-27		9/16"	37,6	19,8	16,5	27	PD322	
	1/8"	1/4"-18		3/4"	41,4	23,6	21,9	54	PD342	
 <p>Male NPTF Thread – SAE J 476</p>	1/8"	1/8"-27		11/16"	39,4	21,6	20,1	77	PD323	
	1/8"	1/4"-18		11/16"	37,6	19,8	20,1	27	PD343	
	1/8"	3/8"-18		13/16"	38,1	20,3	23,8	40	PD363	
 <p>Male Metric Thread to ISO 6149</p>	1/8"	M 14 x 1,5		17 mm	35,0	17,3	19,6	32	PD367-1A	

# Plugs

# PD-Series

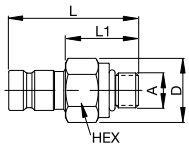
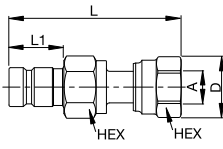
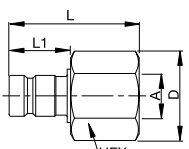
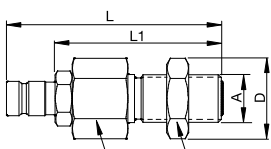
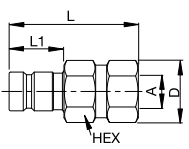
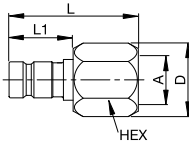
	Body Size	Connec- tion A	Tube Size	Hex	L mm	L1 mm	D mm	Weight gr.	Part number
 <p>Male UNF Thread - SAE 1926</p>	1/8"	7/16"-20		11/16"	40,6	22,9	20,1	36	PD341
	1/8"	1/2"-20		5/8"	33,5	15,7	18,3	22	PD351 *
	1/8"	9/16"-18		11/16"	33,5	15,7	20,1	27	PD361 *
 <p>O-Lok SAE J 1453 / ISO 8434-3</p>	1/8"	9/16"-18	1/4" (6 mm)	11/16"	55,4	17,8	20,1	54	PD34BTL
	1/8"	1 1/16"-16	3/8" (10 mm)	13/16"	58,4	17,8	23,9	63	PD36BTL
 <p>O-Lok SAE J 1453 / ISO 8434-3</p>	1/8"	13/16"-16	1/2" (12 mm)	1 5/16"	28,4	17,8	38,4	58	PD38BTL *
 <p>Bulkhead O-Lok SAE J 1453 / ISO 8434-3</p>	1/8"	9/16"-18	1/4" (6 mm)	13/16"	75,7	57,9	23,8	86	PD346 *
 <p>Triple-Lok SAE J 514 - ISO 8434-2</p>	1/8"	9/16"-18	3/8" (10 mm)	11/16"	42,2	17,8	20,1	40	PD36BTX *
 <p>Triple-Lok SAE J 514 - ISO 8434-2</p>	1/8"	1 1/16"-12	3/4" (20 mm)	1 1/4"	35,3	17,8	36,5	122	PD312BTX

\* Add 6 to part number to include the dust cap.

Body Size	Version	Part number
1/8"	for plug	PD6-285

Other material (EPDM / FKM / HNBR) are available on request.

# DG-Series



### Technical Description

Can be used in hydraulic systems where rotating connections are essential, for example on accessories with rotating movements. Depending on design, the body is made of brass (DG) or steel (KR) and the rotating axis of surface-purified/stainless steel. Maximum rotation speed: 60 r.p.m.

### Advantages

Rotating joints minimise the high wear to the hose, which occurs in hydraulic systems. Solid construction with two plain bearings (DG) or ball/roller bearings (KR). Suitable for combining with norm hydraulic components.

### Working Temperature

-40°C up to +90°C (NBR) depending on the medium. Special seals are available on request (see page 6 ff).

### Applications Area



Material	Type DG	Type KR
Body	Brass	Steel, zinc plated, passivated, sealed
Counterpart		Steel, zinc plated, passivated, sealed
Swivel Axis	Steel, nitrated or Stainless Steel	Steel hardened, zinc plated, passiv., sealed
Nut/Adapter	Steel, zinc plated, passivated, sealed	Steel, zinc plated, passivated, sealed
Seals	NBR	NBR

## Type DG 250 DN 6 = 28 mm

## DG-Series

	Connection A	Connection A1	Hex mm	L mm	D mm	DN	Seal	Type	Working Pressure in bar	Part Number
<p>Female Thread</p>	G 1/4	G 3/8	22	53	23	6	NBR	1	250	250
	G 1/4	G 3/8	22	53	23	6	NBR	1	250	250 RF *

## Type DG 500 DN 11 = 95 mm

## DG-Series

	Connection A	Connection A1	Hex mm	L mm	D mm	DN	Seal	Type	Working Pressure in bar	Part Number
<p>Female Thread</p>	G 1/2	G 3/4	32	71	35	11	NBR	1	250	500
	G 1/2	G 3/4	32	71	35	11	NBR	1	250	500 RF *

\* Swivelling axis made of stainless steel

# Type DG 500 DN 11 = 95 mm

# DG-Series

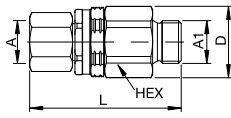
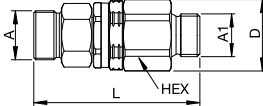
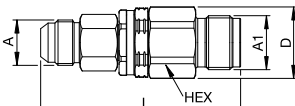
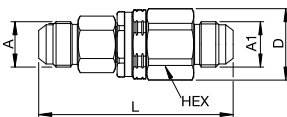
	Connection A	Connection A1	Hex mm	L mm	D mm	DN	Seal	Type	Working Pressure in bar	Part Number
 <p>Male / Female Thread</p>	G 1/2	G 1/2	32	73	35	11	NBR	1A	250	500 B
 <p>Male Thread</p>	M 18 x 1,5	G 1/2	32	73	35	11	NBR	2	250	500 W
	M 22 x 1,5	G 1/2	32	81	35	11	NBR	2	250	500 W5
	M 24 x 1,5	G 1/2	32	81	35	11	NBR	2	250	500 W6
 <p>Male Thread</p>	7/8"-14 UNF	G 3/4	32	95	35	11	NBR	3	250	500-30
	7/8"-14 UNF	G 1/2	32	87	35	11	NBR	3	250	500-32 *
 <p>Male Thread</p>	7/8"-14 UNF	7/8"-14 UNF	32	92	35	11	NBR	3A	250	500-31
	11/16"-12 UNF	11/16"-12 UNF	32	101	35	11	NBR	3A	250	500-33

# Type DG 750 DN 17 = 225 mm

# DG-Series

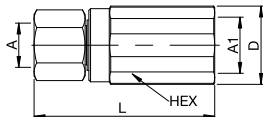
	Connection A	Connection A1	Hex mm	L mm	D mm	DN	Seal	Type	Working Pressure in bar	Part Number
 <p>Female Thread</p>	G 3/4	G 1	40	80	35	17	NBR	1	250	750-QC
	G 3/4	G 1	40	80	35	17	NBR	1	250	750 RF *

\* Swivelling axis made of stainless steel

## Type DG 1000 DN 22 = 380 mm

## DG-Series

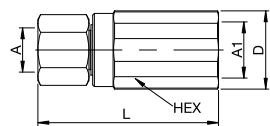

Female Thread

Connection A	Connection A1	Hex mm	L mm	D mm	DN	Seal	Type	Working Pressure in bar	Part Number
G 1	G 1 1/4	50	94	43	22	NBR	1	200	1000-QC
G 1	G 1 1/4	50	94	43	22	NBR	1	200	1000 RF *

\* Swivelling axis made of stainless steel

## Type KR DN 6 = 28 mm up to DN 22 = 380 mm

## KR-Series

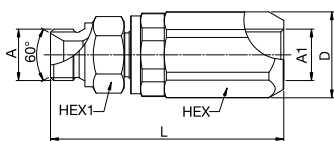

Male / Female Thread

Connection A	Connection A1	Hex mm	Hex 1 mm	L mm	D mm	DN	Seal	Working Pressure in bar	Part Number
G 1/4	G 1/4	27	19	88	29	6	NBR	350	2KR AW13 IW13
G 3/8	G 3/8	30	22	87	33	9	NBR	350	3KR AW17 IW17
G 1/2	G 1/2	32	27	95	35	11	NBR	350	5KR AW21 IW21
G 3/4	G 3/4	45	32	109	50	17	NBR	350	7KR AW26 IW26
G 1	G 1	50	40	117	55	22	NBR	250	10KR AW33 IW33

## Type KR 90° DN 6 = 28 mm up to DN 22 = 380 mm

## KR-Series

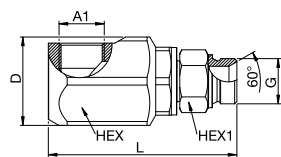

Male / Female Thread

Connection A	Connection A1	Hex mm	Hex 1 mm	L mm	D mm	DN	Seal	Working Pressure in bar	Part Number
G 1/4	G 1/4	32	19	93	35	6	NBR	350	2KRAW13IW1390
G 3/8	G 3/8	38	22	95	41	9	NBR	350	3KRAW17IW1790
G 1/2	G 1/2	41	27	108	45	11	NBR	350	5KRAW21IW2190
G 3/4	G 3/4	55	32	125	60	17	NBR	350	7KRAW26IW2690
G 1	G 1	65	40	139	72	22	NBR	250	10KRAW33IW3390

All KR swivel joints are only suitable for oil.



Accessories

# Pressure Relief Valve



**Technical Description**

Produced for hydraulic systems where in line quick connect couplings are used. The system pressure built up between the hydraulic unit and the coupling would not allow mechanical coupling.

**Advantages**

The Pressure Relief Valve can be mounted directly in the main inflow line so that all downstream pipe or hose lines where quick connect couplings or plugs are installed at the ends can be depressurised.

**Working Pressure**

max. 250 bar

**Working Temperature**

up to max. +90°C depending on the medium. Special seals are available on request (see page 6 ff).

Material	Standard
T-Connection	Steel, zinc plated, passivated, sealed
Pressure Relief Valve	Brass
Seal	NBR

**Applications Area**



## Pressure Relief Valve Accessories

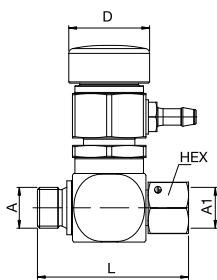

Female / Male Thread

Connection A	Connection A1	Hex mm	L mm	D mm	DN	Seal Type	Max. Working Pressure in bar	Part Number
G 3/8	G 3/8	21	62	33	10	NBR	250	TA38
G 1/2	G 1/2	25	70	33	13	NBR	250	TA50
G 3/4	G 3/4	32	73	33	20	NBR	250	TA75
G 1	G 1	38	77	33	25	NBR	250	TA100

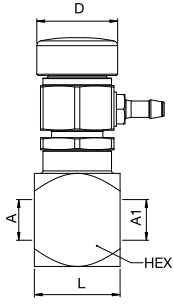
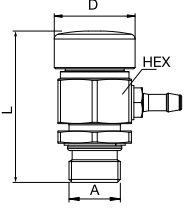

	Connection A	Connection A1	Hex mm	L mm	D mm	DN	Seal Type	Max. Working Pressure in bar	Part Number
 <p>Female Thread</p>	G 3/8	G 3/8	28	60	33	10	NBR	250	TA38 IW
	G 1/2	G 1/2	28	60	33	13	NBR	250	TA50 IW
 <p>Pressure Relief Valve complete</p>	G 1/2		30	62	33	6	NBR	250	515
	G 1/2		30	62	33	6	NBR/FKM	250	515 RV <sup>1</sup>

<sup>1</sup> Swivelling axis made of stainless steel

# DT-Series

# 3/8" and 1 1/4"



### Technical Description

One-piece steel body: eliminates threads and seals that may be potential failure or leakage points. Large range of end configurations. Zinc chromate exterior finish.

### Advantages

No internal gaskets or seals to wear out. Check valve body is shaped like an arrow to indicate flow direction.  
Heat treated poppet valve to resist damage from shocks and surges.  
One piece body eliminates threads and seals that may be potential leakage points.  
Compact design. Easy to plumb into tight circuits.  
Smooth flow stream: Poppet spring is isolated from flow stream minimizing turbulence.

### Working Pressure

max. 350 bar

### Working Temperature

-40°C up to +110°C (NBR) depending on the medium. Special seals are available on request (see page 6 ff).

Material	Standard
Body	Steel
Valve	Steel
Spring	Steel
Seal	NBR
Retainer	Steel

### Standard Crack Pressure:

0,35 bar

### Other Crack Pressure:

Up to 14 bar in 0,35 bar increments are available on request. Please consult your Parker sales engineer.

For other threads, other sizes or other end configurations, please contact your Parker sales engineer.

### Flow Capacity with Oil with Viscosity of 43cSt at 38°C as per ISO 7241/2-2000

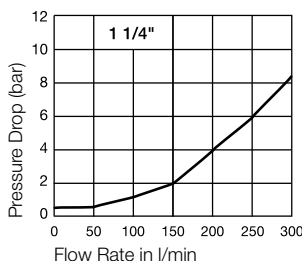
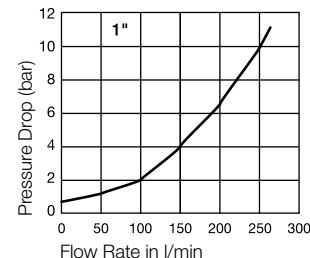
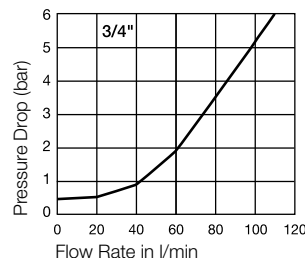
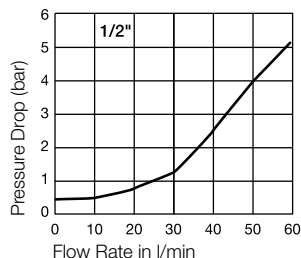
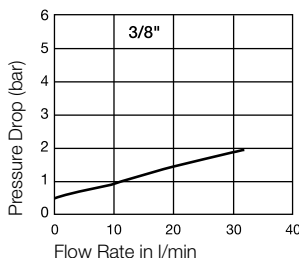

## DT-MFMF: Male JIC 37° Flare Inlet to Male JIC 37° Flare Outlet Accessories

Body Size	Connection A	Connection A1	Hex	L mm	L1 mm	L2 mm	Part Number
	SAE J514 Triple-Lok	SAE J514 Triple-Lok					
3/8"	9/16"-18 UNF	9/16"-18 UNF	3/4"	14,2	11,2	14,2	DT-370-MFMF-5
1/2"	3/4"-16 UNF	3/4"-16 UNF	7/8"	16,8	12,7	16,8	DT-500-MFMF-5
3/4"	1 1/16"-12 UN	1 1/16"-12 UNF	1 1/4"	21,8	12,7	21,8	DT-750-MFMF-5
1"	1 5/16"-12 UN	1 5/16"-12 UNF	1 1/2"	23,1	15,8	23,1	DT-1000-MFMF-5
1 1/4"	1 5/8"-12 UN	1 5/8"-12 UNF	1 7/8"	24,4	26,9	24,4	DT-1250-MFMF-5

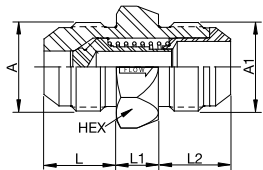

## DT-MOMS: Male ORB Inlet to Male O-Lok Outlet Accessories

Body Size	Con. A – ISO 11926 – 2/3 Male O-Ring Boss	Connection A1 SAE J1453 O-Lok	Hex	L mm	L1 mm	L2 mm	Part Number
1/4"	7/16"-20 UNF	9/16"-18 UNF	5/8"	10,9	11,4	9,9	DT-370-MOMS-5
3/8"	9/16"-18 UNF	11/16"-16 UNF	3/4"	11,9	11,2	11,2	DT-370-MOMS-5
1/2"	3/4"-16 UNF	13/16"-16 UNF	7/8"	14,0	12,7	12,7	DT-500-MOMS-5
3/4"	1 1/16"-12 UNF	1 3/16"-12 UNF	1 1/4"	18,5	12,7	17,0	DT-750-MOMS-5
1"	1 5/16"-12 UNF	1 7/16"-12 UNF	1 1/2"	18,5	15,8	17,5	DT-1000-MOMS-5
1 1/4"	1 5/8"-12 UNF	1 11/16"-12 UNF	1 7/8"	18,5	26,9	17,5	DT-1250-MOMS-5

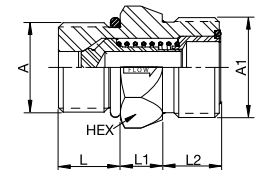

NBR O-Ring included on MO and MS fittings.

## DT-MSMO: Male O-Lok Inlet to Male ORB Outlet Accessories

Body Size	Connection A SAE J1453 O-Lok	Con. A1 – ISO 11926 – 2/3 Male O-Ring Boss	Hex	L mm	L1 mm	L2 mm	Part Number
3/8"	11/16"-16 UNF	9/16"-18 UNF	3/4"	11,9	11,2	11,2	DT-370-MOMS-5
1/2"	13/16"-16 UNF	3/4"-16 UNF	7/8"	14,0	12,7	12,7	DT-500-MOMS-5
3/4"	1 3/16"-12 UNF	1 1/16"-12 UNF	1 1/4"	18,5	12,7	17,0	DT-750-MOMS-5
1"	1 7/16"-12 UNF	1 5/16"-12 UNF	1 1/2"	18,5	15,8	17,5	DT-1000-MOMS-5
1 1/4"	1 11/16"-12 UNF	1 5/8"-12 UNF	1 7/8"	18,5	26,9	17,5	DT-1250-MOMS-5

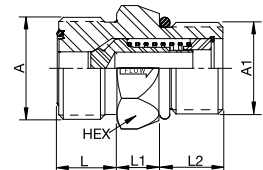

NBR O-Ring included on MO and MS fittings.

## DT-MSMS: Male O-Lok Inlet to Male O-Lok Outlet Accessories

Body Size	Connection A SAE J1453 O-Lok	Connection A1 SAE J1453 O-Lok	Hex	L mm	L1 mm	L2 mm	Part Number
3/8"	11/16"-16 UNF	11/16"-16 UNF	3/4"	11,2	11,2	11,2	DT-370-MSMS-5
1/2"	13/16"-16 UNF	13/16"-16 UNF	7/8"	12,7	12,7	12,7	DT-500-MSMS-5
3/4"	1 3/16"-12 UNF	1 3/16"-12 UNF	1 1/4"	17,0	12,7	17,0	DT-750-MSMS-5
1"	1 7/16"-12 UNF	1 7/16"-12 UNF	1 1/2"	17,5	15,8	17,5	DT-1000-MSMS-5
1 1/4"	1 11/16"-12 UNF	1 11/16"-12 UNF	1 7/8"	17,5	26,9	17,5	DT-1250-MSMS-5

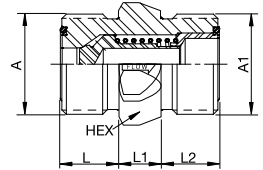

NBR O-Ring included on MO and MS fittings.

# Thermal Valves

# 1"



### Technical Description

Temperature responsive by-pass valve to modulate return line oil between tank and oil cooler. Available in 5 shift temperatures, 38°C to 82°C (100°F to 180°F). Integral relief valve to dump excessive inlet pressures to the reservoir. Relief pressure settings available from 0,34 to 6,0 bar (5 to 85 psi). 17 bar (250 psi) maximum operating pressure. Up to 227 l/m flow rates.

### Advantages

Modulates fluid temperature by either shifting return line flow through the cooler, or by passing directly to the reservoir. Compact construction. 2 mounting hole Ø10,6mm. Aluminium die-cast housing. 3 threaded ports for easy tubing. A built-in pressure relief function automatically relieves excess pressure to the reservoir, should the cooler become restricted and resultant pressure drop become too high for the cooler circuit.

### Applications

Ideally suited for hydrostatic drive circuits which require fast warm-up, controlled fluid temperatures and low return line-back pressure.

### Working Pressure

max. 17 bar

### Working Temperature

-30°C up to +110°C

### Technical Performance Data

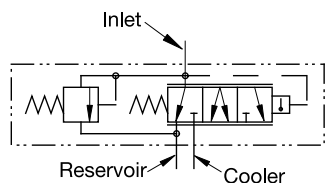

Material	Standard
Body	Aluminium
Valve	Different Materials
Spring	Steel
Seal	NBR, FKM

**Inlet port through Tank port® 38°C**  
Test with oil viscosity 64 cst

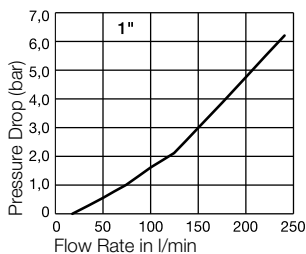

**Inlet port through Cooler port® 63°C**  
Test with oil viscosity 23 cst

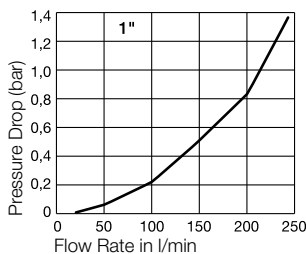

**Inlet port over Integral relief valve® 77°C**  
Test with oil viscosity 16 cst

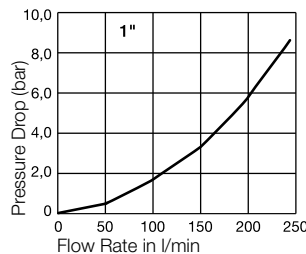

**Note:** Pressure drop shown is added to relief valve crack pressure for total pressure drop.

## Thermal Valves Accessories

	Body Size	Connection A	L mm	L1 mm	D mm	Weight gr.	Part Number
<p>1.312 -12UN-2B SAEJ1926-1-16 SIZE 3 PLACES</p> <p>0.42 [10,7] DIA MOUNTING HOLES 2 PLACES</p>	1"	1 5/16-12 UN	138,2	89,2	66,5	907,0	TH-1000-16FO-*

\* = QQ. Please find the Dash Code for your application in the table on the next page.

## STRUCTURE OF THERMAL VALVES ORDERING

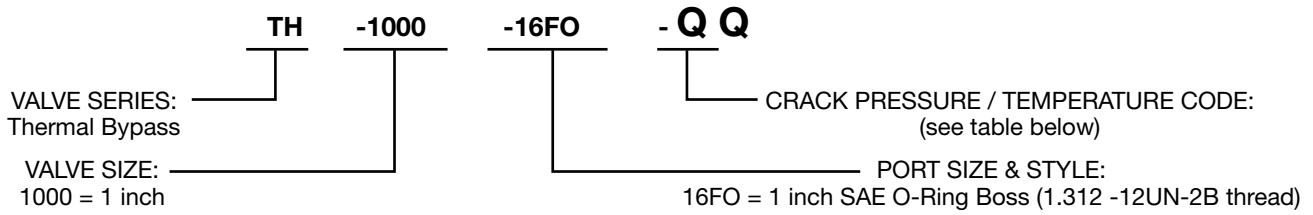

Crack pressure	Shift 38°C	Shift 49°C	Shift 60°C	Shift 71°C	Shift 82°C
0,35 bar	-01	-21	-41	-61	-81
0,70 bar	-02	-22	-42	-62	-82
1,05 bar	-03	-23	-43	-63	-83
1,40 bar	-04	-24	-44	-64	-84
1,70 bar	-05	-25	-45	-65	-85
2,10 bar	-06	-26	-46	-66	-86
2,40 bar	-07	-27	-47	-67	-87
2,75 bar	-08	-28	-48	-68	-88
3,10 bar	-09	-29	-49	-69	-89
3,45 bar	-10	-30	-50	-70	-90
3,80 bar	-11	-31	-51	-71	-91
4,15 bar	-12	-32	-52	-72	-92
4,50 bar	-13	-33	-53	-73	-93
4,85 bar	-14	-34	-54	-74	-94
5,20 bar	-15	-35	-55	-75	-95
5,50 bar	-16	-36	-56	-76	-96
5,85 bar	-17	-37	-57	-77	-97

**Note:** For 2" thermal bypass valve or other thread options, please contact your Parker sales engineer.

# Notices

A series of horizontal dotted lines for writing.

# Notices

A series of horizontal dotted lines for writing.



# Parker's Motion & Control Technologies

At Parker, we're guided by a relentless drive to help our customers become more productive and achieve higher levels of profitability by engineering the best systems for their requirements. It means looking at customer applications from many angles to find new ways to create value. Whatever the motion and control technology need, Parker has the experience, breadth of product and global reach to consistently deliver. No company knows more about motion and control technology than Parker. For further info call 1 800 C-Parker (1 800 272 7537)



## **Aerospace**

### **Key Markets**

Aftermarket services  
Commercial transports  
Engines  
General & business aviation  
Helicopters  
Launch vehicles  
Military aircraft  
Missiles  
Power generation  
Regional transports  
Unmanned aerial vehicles

### **Key Products**

Control systems & actuation products  
Engine systems & components  
Fluid conveyance systems & components  
Fluid metering, delivery & atomization devices  
Fuel systems & components  
Fuel tank inerting systems  
Hydraulic systems & components  
Thermal management  
Wheels & brakes



## **Climate Control**

### **Key Markets**

Agriculture  
Air conditioning  
Construction Machinery  
Food & beverage  
Industrial machinery  
Life sciences  
Oil & gas  
Precision cooling  
Process  
Refrigeration  
Transportation

### **Key Products**

Accumulators  
Advanced actuators  
CO<sub>2</sub> controls  
Electronic controllers  
Filter driers  
Hand shut-off valves  
Heat exchangers  
Hose & fittings  
Pressure regulating valves  
Refrigerant distributors  
Safety relief valves  
Smart pumps  
Solenoid valves  
Thermostatic expansion valves



## **Electromechanical**

### **Key Markets**

Aerospace  
Factory automation  
Life science & medical  
Machine tools  
Packaging machinery  
Paper machinery  
Plastics machinery & converting  
Primary metals  
Semiconductor & electronics  
Textile  
Wire & cable

### **Key Products**

AC/DC drives & systems  
Electric actuators, gantry robots & slides  
Electrohydraulic actuation systems  
Electromechanical actuation systems  
Human machine interface  
Linear motors  
Stepper motors, servo motors, drives & controls  
Structural extrusions



## **Filtration**

### **Key Markets**

Aerospace  
Food & beverage  
Industrial plant & equipment  
Life sciences  
Marine  
Mobile equipment  
Oil & gas  
Power generation & renewable energy  
Process  
Transportation  
Water Purification

### **Key Products**

Analytical gas generators  
Compressed air filters & dryers  
Engine air, coolant, fuel & oil filtration systems  
Fluid condition monitoring systems  
Hydraulic & lubrication filters  
Hydrogen, nitrogen & zero air generators  
Instrumentation filters  
Membrane & fiber filters  
Microfiltration  
Sterile air filtration  
Water desalination & purification filters & systems



## **Fluid & Gas Handling**

### **Key Markets**

Aerial lift  
Agriculture  
Bulk chemical handling  
Construction machinery  
Food & beverage  
Fuel & gas delivery  
Industrial machinery  
Life sciences  
Marine  
Mining  
Mobile  
Oil & gas  
Renewable energy  
Transportation

### **Key Products**

Check valves  
Connectors for low pressure fluid conveyance  
Deep sea umbilicals  
Diagnostic equipment  
Hose couplings  
Industrial hose  
Mooring systems & power cables  
PTFE hose & tubing  
Quick couplings  
Rubber & thermoplastic hose  
Tube fittings & adapters  
Tubing & plastic fittings



## **Hydraulics**

### **Key Markets**

Aerial lift  
Agriculture  
Alternative energy  
Construction machinery  
Forestry  
Industrial machinery  
Machine tools  
Marine  
Material handling  
Mining  
Oil & gas  
Power generation  
Refuse vehicles  
Renewable energy  
Truck hydraulics  
Turf equipment

### **Key Products**

Accumulators  
Cartridge valves  
Electrohydraulic actuators  
Human machine interfaces  
Hybrid drives  
Hydraulic cylinders  
Hydraulic motors & pumps  
Hydraulic systems  
Hydraulic valves & controls  
Hydrostatic steering  
Integrated hydraulic circuits  
Power take-offs  
Power units  
Rotary actuators  
Sensors



## **Pneumatics**

### **Key Markets**

Aerospace  
Conveyor & material handling  
Factory automation  
Life science & medical  
Machine tools  
Packaging machinery  
Transportation & automotive

### **Key Products**

Air preparation  
Brass fittings & valves  
Manifolds  
Pneumatic accessories  
Pneumatic actuators & grippers  
Pneumatic valves & controls  
Quick disconnects  
Rotary actuators  
Rubber & thermoplastic hose & couplings  
Structural extrusions  
Thermoplastic tubing & fittings  
Vacuum generators, cups & sensors



## **Process Control**

### **Key Markets**

Alternative fuels  
Biopharmaceuticals  
Chemical & refining  
Food & beverage  
Marine & shipbuilding  
Medical & dental  
Microelectronics  
Nuclear Power  
Offshore oil exploration  
Oil & gas  
Pharmaceuticals  
Power generation  
Pulp & paper  
Steel  
Water/wastewater

### **Key Products**

Analytical Instruments  
Analytical sample conditioning products & systems  
Chemical injection fittings & valves  
Fluoropolymer chemical delivery fittings, valves & pumps  
High purity gas delivery fittings, valves, regulators & digital flow controllers  
Industrial mass flow meters/controllers  
Permanent no-weld tube fittings  
Precision industrial regulators & flow controllers  
Process control double block & bleeds  
Process control fittings, valves, regulators & manifold valves



## **Sealing & Shielding**

### **Key Markets**

Aerospace  
Chemical processing  
Consumer  
Fluid power  
General industrial  
Information technology  
Life sciences  
Microelectronics  
Military  
Oil & gas  
Power generation  
Renewable energy  
Telecommunications  
Transportation

### **Key Products**

Dynamic seals  
Elastomeric o-rings  
Electro-medical instrument design & assembly  
EMI shielding  
Extruded & precision-cut, fabricated elastomeric seals  
High temperature metal seals  
Homogeneous & inserted elastomeric shapes  
Medical device fabrication & assembly  
Metal & plastic retained composite seals  
Shielded optical windows  
Silicone tubing & extrusions  
Thermal management  
Vibration dampening

ENGINEERING YOUR SUCCESS.



# Parker Worldwide

**AE – UAE, Dubai**  
Tel: +971 4 8127100  
parker.me@parker.com

**AR – Argentina, Buenos Aires**  
Tel: +54 3327 44 4129

**AT – Austria, Wiener Neustadt**  
Tel: +43 (0)2622 23501-0  
parker.austria@parker.com

**AT – Eastern Europe, Wiener Neustadt**  
Tel: +43 (0)2622 23501 900  
parker.easteurope@parker.com

**AU – Australia, Castle Hill**  
Tel: +61 (0)2-9634 7777

**AZ – Azerbaijan, Baku**  
Tel: +994 50 2233 458  
parker.azerbaijan@parker.com

**BE/LU – Belgium, Nivelles**  
Tel: +32 (0)67 280 900  
parker.belgium@parker.com

**BR – Brazil, Cachoeirinha RS**  
Tel: +55 51 3470 9144

**BY – Belarus, Minsk**  
Tel: +375 17 209 9399  
parker.belarus@parker.com

**CA – Canada, Milton, Ontario**  
Tel: +1 905 693 3000

**CH – Switzerland, Etoy**  
Tel: +41 (0)21 821 87 00  
parker.switzerland@parker.com

**CL – Chile, Santiago**  
Tel: +56 2 623 1216

**CN – China, Shanghai**  
Tel: +86 21 2899 5000

**CZ – Czech Republic, Klecany**  
Tel: +420 284 083 111  
parker.czechrepublic@parker.com

**DE – Germany, Kaarst**  
Tel: +49 (0)2131 4016 0  
parker.germany@parker.com

**DK – Denmark, Ballerup**  
Tel: +45 43 56 04 00  
parker.denmark@parker.com

**ES – Spain, Madrid**  
Tel: +34 902 330 001  
parker.spain@parker.com

**FI – Finland, Vantaa**  
Tel: +358 (0)20 753 2500  
parker.finland@parker.com

**FR – France, Contamine s/Arve**  
Tel: +33 (0)4 50 25 80 25  
parker.france@parker.com

**GR – Greece, Athens**  
Tel: +30 210 933 6450  
parker.greece@parker.com

**HK – Hong Kong**  
Tel: +852 2428 8008

**HU – Hungary, Budapest**  
Tel: +36 1 220 4155  
parker.hungary@parker.com

**IE – Ireland, Dublin**  
Tel: +353 (0)1 466 6370  
parker.ireland@parker.com

**IN – India, Mumbai**  
Tel: +91 22 6513 7081-85

**IT – Italy, Corsico (MI)**  
Tel: +39 02 45 19 21  
parker.italy@parker.com

**JP – Japan, Tokyo**  
Tel: +81 (0)3 6408 3901

**KR – South Korea, Seoul**  
Tel: +82 2 559 0400

**KZ – Kazakhstan, Almaty**  
Tel: +7 7272 505 800  
parker.easteurope@parker.com

**MX – Mexico, Apodaca**  
Tel: +52 81 8156 6000

**MY – Malaysia, Shah Alam**  
Tel: +60 3 7849 0800

**NL – The Netherlands, Oldenzaal**  
Tel: +31 (0)541 585 000  
parker.nl@parker.com

**NO – Norway, Asker**  
Tel: +47 66 75 34 00  
parker.norway@parker.com

**NZ – New Zealand, Mt Wellington**  
Tel: +64 9 574 1744

**PL – Poland, Warsaw**  
Tel: +48 (0)22 573 24 00  
parker.poland@parker.com

**PT – Portugal, Leca da Palmeira**  
Tel: +351 22 999 7360  
parker.portugal@parker.com

**RO – Romania, Bucharest**  
Tel: +40 21 252 1382  
parker.romania@parker.com

**RU – Russia, Moscow**  
Tel: +7 495 645-2156  
parker.russia@parker.com

**SE – Sweden, Spånga**  
Tel: +46 (0)8 59 79 50 00  
parker.sweden@parker.com

**SG – Singapore**  
Tel: +65 6887 6300

**SK – Slovakia, Banská Bystrica**  
Tel: +421 484 162 252  
parker.slovakia@parker.com

**SL – Slovenia, Novo Mesto**  
Tel: +386 7 337 6650  
parker.slovenia@parker.com

**TH – Thailand, Bangkok**  
Tel: +662 717 8140

**TR – Turkey, Istanbul**  
Tel: +90 216 4997081  
parker.turkey@parker.com

**TW – Taiwan, Taipei**  
Tel: +886 2 2298 8987

**UA – Ukraine, Kiev**  
Tel: +380 44 494 2731  
parker.ukraine@parker.com

**UK – United Kingdom, Warwick**  
Tel: +44 (0)1926 317 878  
parker.uk@parker.com

**US – USA, Cleveland**  
Tel: +1 216 896 3000

**VE – Venezuela, Caracas**  
Tel: +58 212 238 5422

**ZA – South Africa, Kempton Park**  
Tel: +27 (0)11 961 0700  
parker.southafrica@parker.com

**Parker Hannifin Manufacturing  
Germany GmbH & Co. KG**  
Quick Coupling Division Europe  
Daimlerstr. 7  
71735 Eberdingen – Germany  
Phone +49 7042 100 0  
Fax +49 7042 100 147  
www.rectus.de



ENGINEERING YOUR SUCCESS.